



Last version of this manual
IP2336EN • 2022-09-30

Ditec

Ditec LCU43A - LCU43B

Installation manual for control panel for the CROSS20VEI and CROSS35VEI automation systems with 230 V 3~ motor
(Translation of the original instructions)

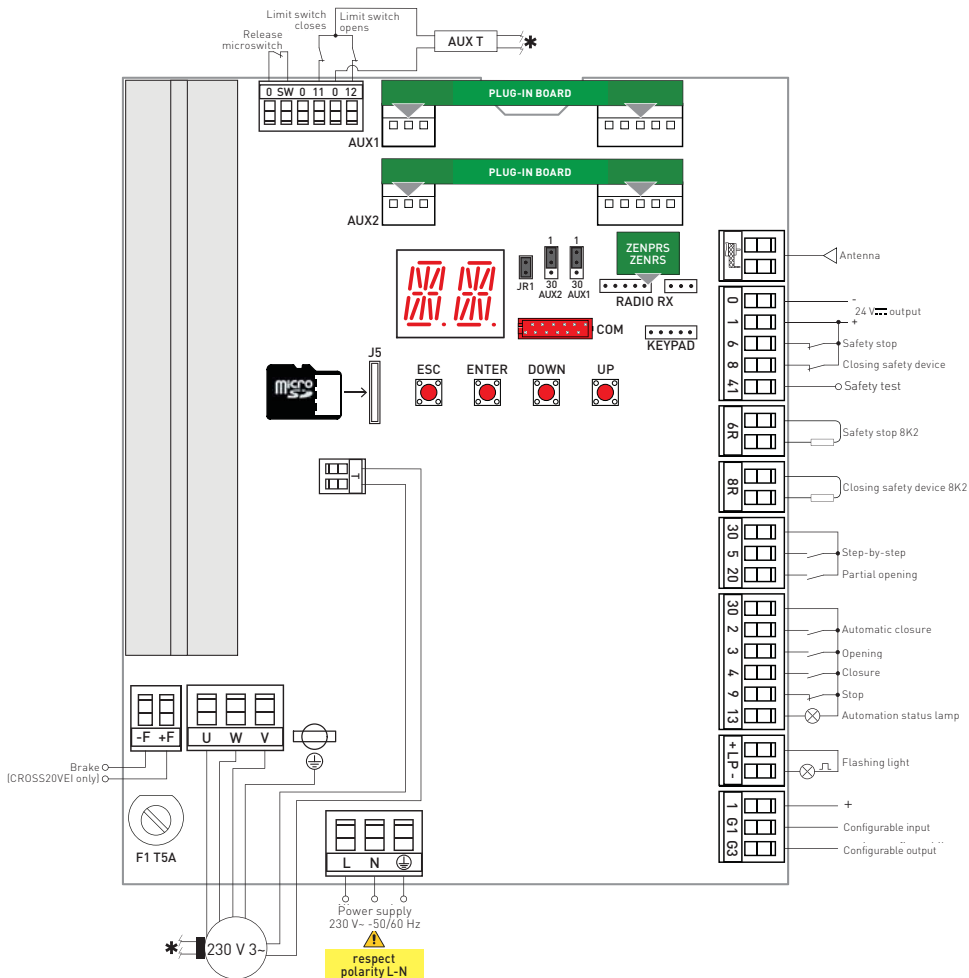

Contents

General safety precautions for the user	3
General safety precautions	5
EU Declaration of Conformity	7
UK Declaration of Conformity	8
1. Safety functions	9
2. Technical specifications	9
2.1 Applications	9
3. Installation and electrical connections	10
4. Standard installation	12
4.1 Standard installation connections diagram	13
5. Commands and safety devices	14
5.1 Safety inputs	15
5.2 Limit switch inputs	15
6. Outputs and accessories	16
7. Jumper setting	17
8. Using menus	18
8.1 Switching the display ON and OFF	18
8.2 Navigation keys	19
8.3 Menu map	20
9. Setting up product for first use	22
9.1 Wizard configuration menu (WZ)	22
9.2 Basic start-up example	24
10. Frequently used menu sequences	25
10.1 Enabling the configurations	25
10.2 Adding remote controls	25
10.3 Configuring the NC contact safety devices	25
10.4 Configuring the resistive safety edges	25
10.5 Synthetic diagram of operation	26
11. Configuration and settings menu	27
11.1 Main menu	27
11.2 Second level menu - AT (Automatic Configurations)	28
11.3 Second level menu - BC (Basic Configurations)	29
11.3.1 Additional BC level parameters that can be configured [available with AT → AA enabled]	30
11.4 Second level menu - BA (Basic Adjustment)	31
11.4.1 Additional BA level parameters that can be configured [available with AT → AA enabled]	32
11.5 Second level menu - RO (Radio Operations)	35
11.5.1 Additional configurable RO level parameters available with AT → AA enabled	36
11.6 Second level menu - SF (Special Functions)	37
11.6.1 Additional configurable SF level parameters available with AT → AA enabled	38
11.7 Second level menu - CC (Cycles Counter)	40
11.7.1 Additional configurable CC level parameters available with AT → AA enabled	40
11.8 Second level menu - EM (Energy Management)	41
11.9 Second level menu - AP (Advanced Parameters)	41
11.9.1 Additional AP level parameters that can be configured [available with AT → AA enabled]	42
12. Diagnostics	45
12.1 Data Logging integrated in the card	45
12.1.1 Alarm counter	45
12.1.2 Alarm log	45
12.1.3 Exporting information on the microSD	45
12.2 Extended data logging on microSD	46
13. Examples of application for parallel automations	48
13.1 Examples of application for interlocked automations with one-way or two-way transit, without presence detection	50
13.2 Examples of application for interlocked automations with one-way transit, with presence detection	52
14. Signals visualised on the display	54
14.1 Display of automation status	54
14.2 Display of safety devices and commands	54
14.2.1 Messages visible if G1= SY	55
14.3 Visualisation of alarms and faults	56
15. Troubleshooting	59
16. Maintenance	60

Key



This symbol indicates instructions or notes regarding safety, to which special attention must be paid.



This symbol indicates useful information for the correct operation of the product.

Factory settings

General safety precautions for the user



WARNING! Important safety instructions • Follow these instructions carefully. Failure to respect the information given in this manual may lead to serious injury to people or damage to the device • Keep these instructions for future reference

WARNING: disconnect the power supply before carrying out any cleaning or maintenance task This manual, and those relating to accessories, can be downloaded from the website www.ditecautomations.com

These precautions are an integral and essential part of the product and must be supplied to the user. Read them carefully as they contain important indications for safe installation, use and maintenance • Keep these instructions and pass them on to anyone else who uses the system • This device must only be used for the specific purpose for which it was designed; any other use is to be considered improper and therefore dangerous. The manufacturer cannot be held responsible for any damage caused by improper, incorrect or unreasonable use • Do not work near hinges or moving mechanical parts. Do not enter within the operating range of the motorised door or gate while it is moving. Do not obstruct the movement of the motorised door or gate, as this may lead to a dangerous situation • Only lock and release the door wings with the motor switched off. Do not enter within the operating range of the motorised door or gate • When working in “hold-to-run” mode, the relative command devices must be positioned so as to ensure a direct, complete view of the door or gate during operations, far away from moving parts, at a minimum height of 1.5 m, and not accessible by the public • The motorised door or gate may be used by children over the age of 8 and people with a reduced physical, sensorial or mental capacity, or without the necessary knowledge and experience, as long as they are supervised or have received instructions regarding safe use and the inherent risks • Children

must be supervised to ensure they do not play with the device itself, nor play or remain within the operating range of the motorised door or gate. Keep the remote controls and/or any other control device out of the reach of children, to avoid any accidental activation of the motorised door or gate • The cleaning and maintenance tasks that are the responsibility of the user must not be carried out by unsupervised children • In the event of a fault or malfunctioning of the device, disconnect the power supply switch; do not attempt to make any repairs or intervene directly in any way. Any repairs or technical interventions must be carried out by qualified personnel. Failure to respect the indications above may lead to dangerous situations • To ensure the system works efficiently and correctly, it is essential to respect the manufacturer's indications and have scheduled maintenance on the motorised door or gate carried out by qualified personnel. In particular, regular checks must be made to ensure all the safety devices are working properly • Written evidence of all installation, maintenance and repair tasks must be made available to the user.

General safety precautions



WARNING! Important safety instructions.

Follow these instructions carefully. Failure to respect the information given in this manual may lead to serious injury to people or damage to the device.

Keep these instructions for future reference.

This manual, and those relating to accessories, can be downloaded from the website www.ditecautomations.com

This installation manual is intended for qualified personnel only

- The installation, electrical connections and adjustments must be made by qualified personnel, using Good Working Methods and respecting the regulations in force
- Read these instructions carefully before beginning to install the device. Incorrect installation may be a source of danger
- Before beginning the installation, make sure the device is in good condition



- Dispose of the packaging materials (plastic, polystyrene, etc.) responsibly; keep them out of the reach of children, as they are a potential source of danger
- Do not install the device in an explosive atmosphere or area: the presence of gas or inflammable fumes are a serious safety hazard
- Make sure the place of use is compatible with the working temperature range indicated in the technical specifications
- Before installing the motorisation device, check that the existing structure and the support and guide elements meet the robustness and stability requisites; check the stability and smooth operation of the guided part, and make sure there is no risk of it slipping out of its track or tipping over. Make all the structural modifications necessary in order to create safety clearance and to guard or isolate all the crushing, shearing, trapping and general danger areas. The motorisation device manufacturer is not responsible for failure to observe Good Working Methods when building the frames to be motorised, nor for any deformation during use
- When installing the safety devices (photocells, safety edges, emergency stops, etc.), the current standards and directives must be taken into consideration along with Good Working Methods criteria, the place of installation, the system operating logic and the forces developed by the motorised door or

gate • The safety devices must protect any possible crushing, shearing, trapping or general danger areas of the motorised door or gate. Apply the legally required signs to identify the danger areas • The motorised door or gate ID data must be visible on every installation • Before connecting the electricity supply, make sure the mains power supply corresponds to the plate data. An omnipolar disconnection switch with a contact opening distance of at least 3mm must be fitted on the mains supply. Check there is a suitable circuit breaker and overcurrent cut-out upstream from the electrical system, to respect Good Working Methods and the regulations in force • When necessary, connect the motorised door or gate to an earth system that meets the current safety regulations • Before leaving the system in the hands of the end user, make sure the automation is properly adjusted to satisfy the operating and safety requisites, and that all the command, safety and manual release devices are working correctly.



When maintenance and repair work needs to be carried out, disconnect the electricity supply before opening the cover to access the electrical parts • The protective cover on the automation must only be removed by qualified personnel • To carry out those operations involving access to the inside of the control panel in the presence of power, such as may be the adjustment of operating parameters, it is mandatory to wear personal protective equipment in accordance with the law for live operation, especially safety dielectric gloves approved at least as Class 00 (500 V) according to EN 60903.



The electronic parts must be handled using earthed antistatic conductive arms. The motorisation device manufacturer disclaims all responsibility if components incompatible in terms of safety and good operation are installed • Only original spare parts must be used when repairing or replacing the device • The installer must provide the system user with all the information regarding the automatic, manual and emergency operation of the motorised door or gate, along with the operating and safety instructions.

EU Declaration of Conformity

We:

ASSA ABLOY Entrance Systems AB
Lodjursgatan 10
SE-261 44 Landskrona
Sweden

Declare under our sole responsibility that the types of equipment with names:

Ditec LCU43A, Ditec LCU43B Control panel for CROSS20VEI and CROSS35VEI automation systems with 230 V 3- motor

Comply with the following directives and their amendments:

2014/35/EU	Low Voltage Directive (LDV)
2014/30/EU	Electromagnetic Compatibility Directive (EMCD)
2014/53/EU	RED Directive;
2011/65/EU	Restriction of hazardous substances (RoHS 2)
2015/863/EU	Restriction of hazardous substances (RoHS 2 Amendment)

Harmonized European standards that have been applied:

EN 61000-6-3:2007 + A1:2011 + AC:2012
EN 61000-6-2:2019
EN 60335-1:2012 + AC:2014 + A11:2014 + A13:2017 + A1:2019 + A14:2019 + A2:2019
EN 60529:1991 + A1:2000 + A2:2013 + AC:2016
EN 62233:2008 + AC:2008
EN ISO 13849-1:2015

Other standards or technical specifications that have been applied:

IEC 60335-1:2010 + C1:2010 + C2:2011 + A2:2013 + C1:2014 + A2:2016 + C1:2016
EN 12453:2017

The manufacturing process ensures the compliance of the equipment with the technical file.

Responsible for technical file:

Matteo Fino
BSP Ind channel & Gate Automation
Ditec S.p.A.
Largo U. Boccioni, 1
21040 Origgio (VA)
Italy

Signed for and on behalf of ASSA ABLOY Entrance Systems AB by:

Place	Date	Signature	Position
Origgio	2022-09-30	Matteo Fino	Head of Ind channel & Gate Automation

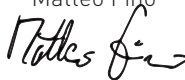

UK Declaration of Conformity

We:

ASSA ABLOY Entrance Systems AB
Lodjursgatan 10
SE-261 44 Landskrona
Sweden

Declare under our sole responsibility that the types of equipment with names:

Ditec LCU43A, Ditec LCU43B Control panel for CROSS20VEI and CROSS35VEI automation systems
with 230 V 3~ motor

Comply with the following directives and their amendments:

- Supply of Machinery (Safety) Regulations 2016
- Electrical Equipment (Safety) Regulations 2016
- Electromagnetic Compatibility Regulations 2016
- Radio Equipment Regulations 2017
- The Restriction of the Use of Certain Hazardous Substances in Electrical and Electronic Equipment Regulations 2012 (RoHS)

Harmonized European standards that have been applied:

EN 61000-6-3:2007 + A1:2011 + AC:2012

EN 61000-6-2:2019

EN 60335-1:2012 + AC:2014 + A11:2014 + A13:2017 + A1:2019 + A14:2019 + A2:2019

EN 60529:1991 + A1:2000 + A2:2013 + AC:2016

EN 62233:2008 + AC:2008

EN ISO 13849-1:2015

Other standards or technical specifications that have been applied:

IEC 60335-1:2010 + C1:2010 + C2:2011 + A2:2013 + C1:2014 + A2:2016 + C1:2016

EN 12453:2017

The manufacturing process ensures the compliance of the equipment with the technical file.

Responsible for technical file:

Matteo Fino
BSP Ind channel & Gate Automation
Ditec S.p.A.
Largo U. Boccioni, 1
21040 Origgio (VA)
Italy

Signed for and on behalf of ASSA ABLOY Entrance Systems AB by:

Place	Date	Signature	Position
Origgio	2022-09-30	Matteo Fino	Head of Ind channel & Gate Automation



1. Safety functions

The Ditec LCU43A and LUC43B control panel has the following safety functions:

- obstacle recognition with force limiting;





The maximum response time of the safety functions is 0.5s. The reaction time to a faulty safety function is 0.5s.

The safety functions comply with the standards and performance level indicated below:

EN ISO 13849-1:2015 Category 2 PL=c
EN ISO 13849-2:2012

The safety function cannot be bypassed either temporarily or automatically. Fault exclusion has not been applied.

2. Technical specifications

	LCU43A	LCU43B
Power supply	230 V~, -10%/ +10%, 50/60 Hz	
Power absorption	3,5 A	4,0 A
Fuse	F1= T5A	
Motor output	Inverter 230 V 3~; 1 x 6 A max	Inverter 230 V 3~; 1 x 9 A max
Permanent power supply to accessories 0-30	24 V $\overline{=}$ 0,15 A	 WARNING: in any case, the total of accessories 0-30 and 0-1 must not exceed 0,5 A
Power supply to accessories 0-1	24 V $\overline{=}$ 0,5 A (continuous)	
Ambient temperature	  -20 °C - +55 °C	
Storable radio codes	100/200	[see RO → MU → 10/20]
Radio frequency	433,92 MHz (cod. ZENRS) 868,35 MHz (cod. ZENPRS)	 ZENRS receiver module included, ZENPRS optional
Protection rating of the box	refer to the technical data sheet for the CROSS20VEI automation system	refer to the technical data sheet for the CROSS35VEI automation system
Product size	187x261x103 mm	238x357x120 mm

 **NOTE:** The given operating and performance features can only be guaranteed with the use of DITEC accessories and safety devices.

2.1 Applications

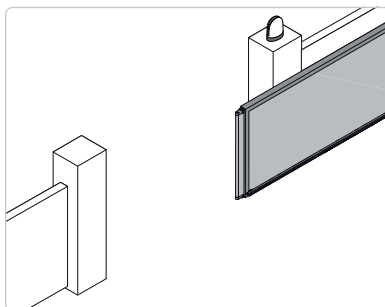

3. Installation and electrical connections

- Before connecting the power supply, make sure the plate data correspond to those of the mains power supply.
- An omnipolar disconnection switch with a contact opening distance of at least 3mm must be fitted on the mains supply.
- Check there is an adequate residual current circuit breaker and overcurrent cut-out upstream of the electrical system.
- For the power supply, use a H05RN-F 3G1.5 type electric cable. Connect it to terminals L (brown), N (blue),  (yellow/green) inside the automation.
- Pass the power supply cable through the supplied ferrite filter as shown in figures 3.1 and 3.2.

NOTE: the maximum permitted wire section is AWG14 (2mm²).

- Unsheathe the power supply cable in line with the terminal.
- In order to comply with the essential requisites of the Standards in force, reclose the cover once the connections with the terminal have been made.



The connections to the mains power supply and to any possible low voltage wires (230 V) in the section outside the electronic panel must be made on an independent channel separated from the connections to the command and safety devices (SELV = Safety Extra Low Voltage). The corrugated tubes must enter the electronic panel by a few centimetres via the slots on the base box.

- Make sure there are no sharp edges that may damage the cables.
- Make sure the mains power wires (230 V) and the accessory wires (24 V) are separated.
- Pass the control cables through the ferrite filters as in figures 3.1 and 3.2.
- The cables must have dual insulation. Unsheathe them in line with the relative connection terminals.

CROSS20VEI

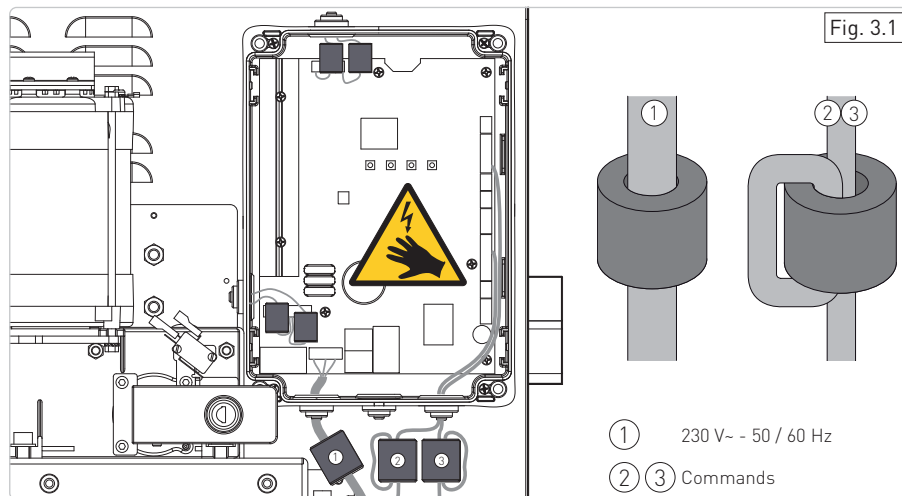

CROSS35VEI

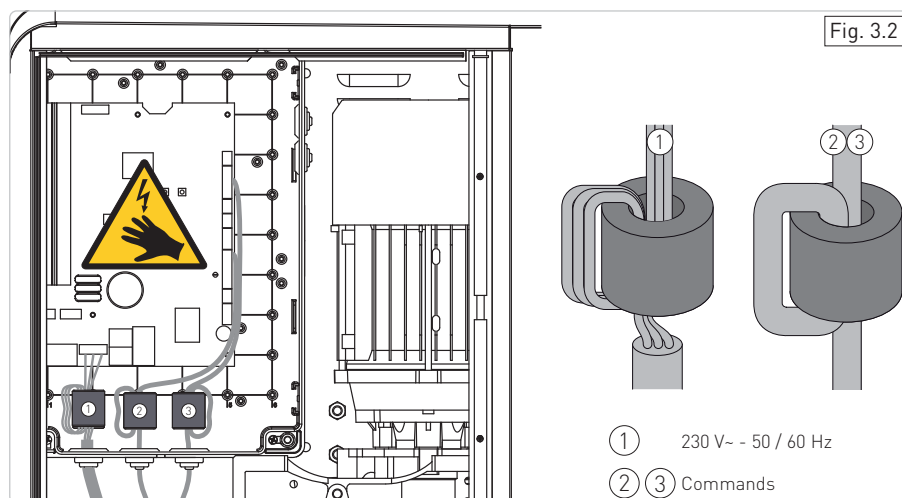

4. Standard installation

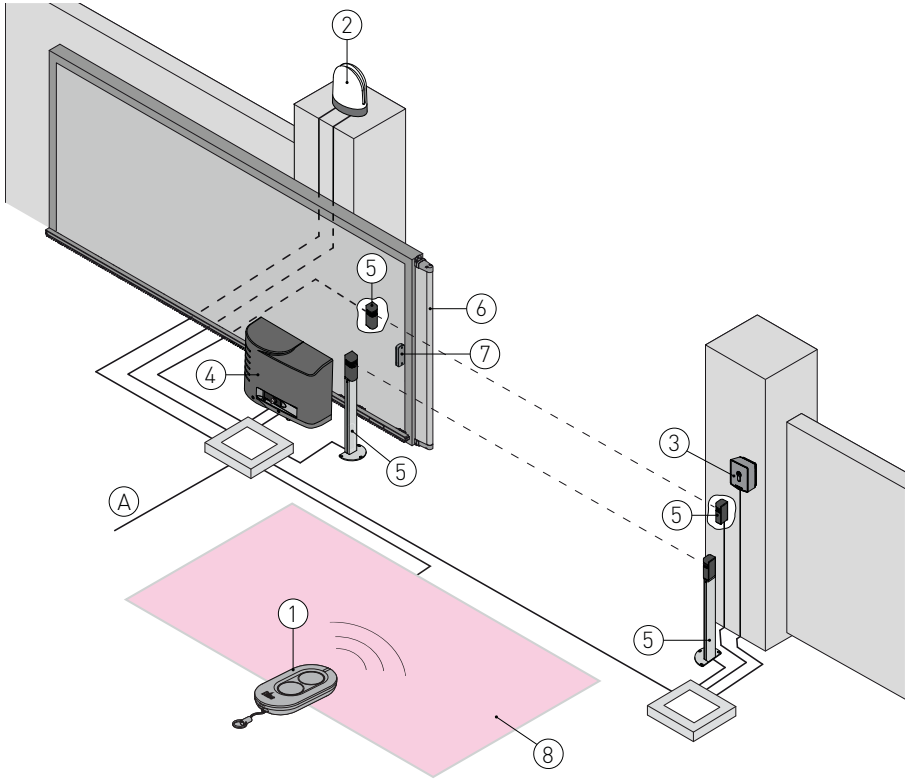

Ref.	Code	Description	Cable
1	ZEN	Transmitter	/
2	FLM	Flashing light 230 V	2 x 1 mm ²
	FL24	Flashing light 24 V	
3	AXK5	Key selector switch	4 x 0.5 mm ²
	AXR7 AXK4	Transponder Digital combination wireless keypad	
4	CROSS20VEI CROSS35VEI	Actuator (motor) 230 V 3~	3G x 1.5 mm ²
A		Connect the power supply to a certified-compliant omnipolar switch (not included) with a contact opening distance of at least 3mm. Connection to the mains must be via an independent conduit, separated from the connections to the command and safety devices.	
5	LIN2 LIN2B AXP2 LAB4	Photocells Photocells Photocells Photocells IP55	4 x 0.5 mm ²
6	SOFAP20	Safety edge	2 x 0,5 mm ² min
	SOF2M20-SOF3M20	Safety edge	
	SOFA15-SOFA20-SOFA25	Safety edge	
7	GOPAV	Radio system for sensitive edges	/
8	LAB9	Magnetic loop detector	2 x 1,5 mm ²

4.1 Standard installation connections diagram

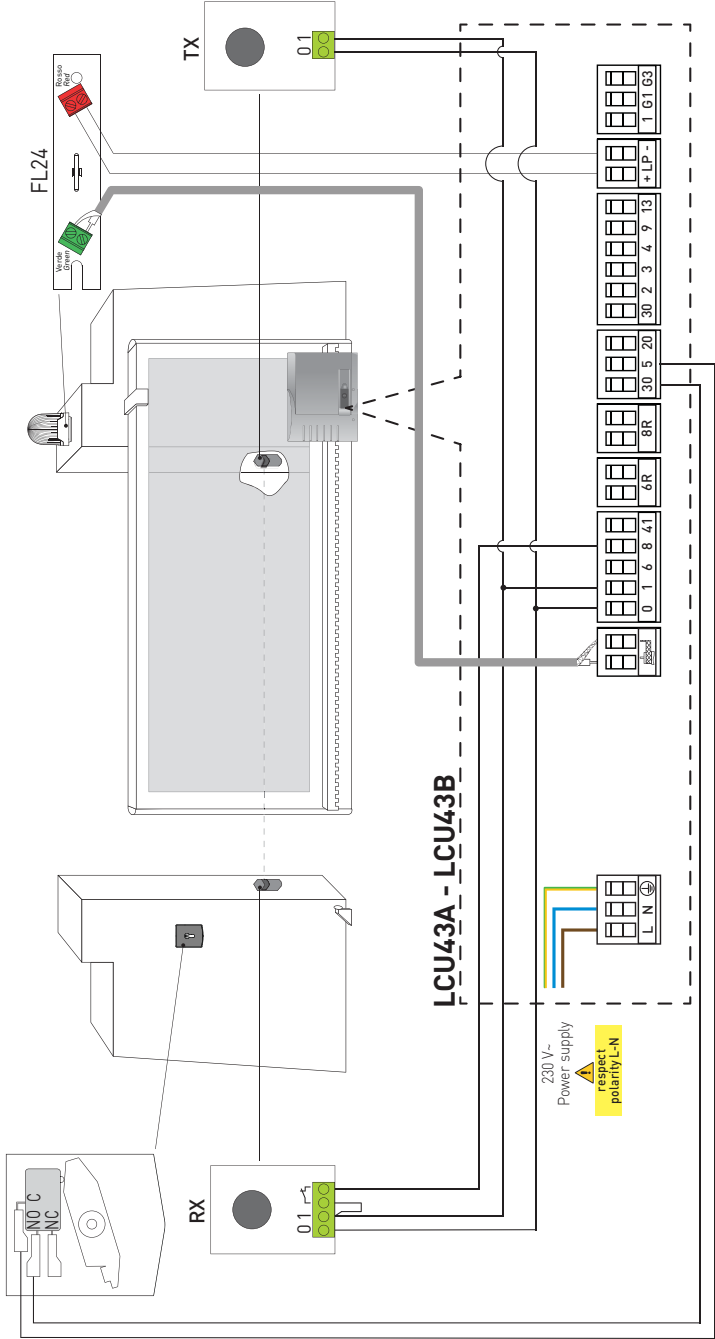

5. Commands and safety devices











You are advised to read paragraph 11 for all the details about the possible adjustments.







WARNING: terminal 30 (common positive for commands) has the same functions as terminal 1 and for this reason, the commands visible on the display are indicated with 1-5, 1-3, 1-4, etc. However, unlike terminal 1, it is also active when the control panel is in stand by **ES** → **ON**.



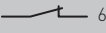
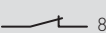

WARNING: make a jumper for all NC contacts if not used, or deactivate them via the relative menu. Terminals with the same number are equal.

Command	Function	Description
30  2	NO	AUTOMATIC CLOSURE Permanent closing of the contact enables automatic closure if AC → I-2
30  3	NO	OPENING When selecting BC → 3S → I-3 , the closure of the contact activates an opening operation.
	NO	STEP-BY-STEP When selecting BC → 3S → I-5 , the closure of the contact activates a sequential opening or closing operation: opening-stop-closing-opening. The "opening-stop-closing-opening" sequence can be changed to "opening-stop-closing-stop-opening" by selecting BC → PP .
30  4	NO	CLOSURE Closing of the contact activates a closing operation.
30  5	NO	STEP-BY-STEP When selecting BC → CS → I-5 , closing the contact starts a sequential opening or closing operation: opening-stop-closing-opening. WARNING: if automatic closure is enabled, the duration of the stop can be defined by selecting BC → SS . The "opening-stop-closing-opening" sequence can be changed to "opening-stop-closing-stop-opening" by selecting BC → PP .
	NO	OPENING When selecting BC → CS → I-3 , the closure of the contact activates an opening operation.
1  6	NC	SAFETY STOP The opening of the safety contact stops and prevents any movement. NOTE: to set different safety contact functions, refer to the settings of parameter AP → SM .
1  8	NC	CLOSING SAFETY DEVICE The opening of the safety contact triggers a reversal of the movement (reopening) during the closing operation. With BC → SO → ON , the opening of the contact prevents any operation when the automation is stationary. With BC → SO → OF , the opening of the contact only prevents the closing operation when the automation is stationary.
		CLOSING/ OPENING SAFETY DEVICE The opening of the safety contact stops and prevents any movement. NOTE: operation corresponds to that of contact 1-6 with AP → SM → OS .
30  9	NC	STOP The opening of the safety contact causes the current operation to stop. If AP - R9 = 9P , automatic closure is disabled when contact 30-9 recloses. If AP - R9 = 9T , automatic closure remains enabled when contact 30-9 recloses.
30  9	NO	HOLD-TO-RUN COMMAND When selecting AP → R9 → HR , the opening of contact 30-9 enables the "operator present" function: - opening with hold-to-run 30-3 - closure with hold-to-run 30-4 NOTE: any safety devices, automatic closure and plug-in board in the AUX slot are all disabled.
30  20	NO	PARTIAL OPENING The closure of the contact activates a partial opening operation. Once the automation stops, the partial opening control performs the opposite operation to the one performed before the stop.





5.1 Safety inputs

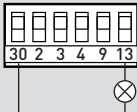

Command		Function	Description
1	 6	NC SAFETY STOP	When selecting AP → DB → 54I , connect the output contact of the safety device to terminals 1-6 on the control panel (in series with the photocell output contact, if installed).
1	 8	NC CLOSING SAFETY DEVICE	When selecting AP → DB → 54I , connect the output contact of the safety device to terminals 1-8 on the control panel (in series with the photocell output contact, if installed).
1	 6 8	NC CLOSING/ OPENING SAFETY DEVICE	When selecting AP → 6B → 54I , connect the output contact of the safety device to terminals 1-6-8 on the control panel (in series with the photocell output contact, if installed). If 6B → 54I , DB and DB cannot be P4I or 54I .
	 6R	R=8,2 kΩ -10%/ +10% OPENING RESISTIVE SAFETY EDGE	With AP → 6R confirmed by NO , a short circuit or open circuit state of the resistor triggers a stop with disengagement and movement direction reversal on the basis of the value set for parameter 6R .
	 8R	R=8,2 kΩ -10%/ +10% CLOSING RESISTIVE SAFETY EDGE	With AP → 8R confirmed by NO , a short circuit or open circuit state of the resistor triggers a stop with disengagement and movement direction reversal on the basis of the value set for parameter 8R .

5.2 Limit switch inputs

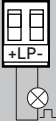

Command		Function	Description
0	 11	NC CLOSING LIMIT SWITCH	Extra low voltage limit switch logic contact.
0	 12	NC OPENING LIMIT SWITCH	Extra low voltage limit switch logic contact.



6. Outputs and accessories

Output	Value of accessories	Description
	24 V $\overline{\text{=}}$ / 0.5A	<p>Power supply to accessories. Output for power supply to external accessories.</p> <p>i NOTE: the maximum power absorption of 0.5 A corresponds to the sum of all terminals 1. The "gate open" indicator light (30-13) is not calculated in the 0.3A indicated above. The maximum value to be considered is 3W.</p>
	24 V $\overline{\text{=}}$ / 3W	<p>Automation status lamp. For the operating mode of output 30-13, refer to the selection BC \rightarrow 13.</p>
	10 mA max	<p>G1 - General Purpose Input Operating of the G1 input can be selected from the menu AP \rightarrow G 1.</p> <p>G3 - General Purpose Output Operating of the G3 output depends on the type of G1 input selection.</p> <p>SY - If G 1 \rightarrow S Y, G3 acts as a sync output for parallel or interlocked automations. ES - Energy Saving mode is not available with this configuration.</p> <p>41 - If the safety test (S Y or P Y) is enabled on one or both inputs DB and DB, G3 acts as an output for the safety device test.</p> <p>30 - G3 acts as a permanent positive at max 24 V 10 mA, to be connected with the NO contact to G1 (opening and/or step-by-step).</p>
AUX 1 AUX 2	SOFA1-SOFA2 GOPAVRS LAB9 BIXR2 BIXPR2 LAN7S	<p>The control panel has two slots for plug-in command and safety boards. The action of the control card can be selected using BC \rightarrow AM for AUX1 and BC \rightarrow AN for AUX2. When using slot-in radio boards, remove the RDX module. The display will show RV.</p> <p>! WARNING: the plug-in board must be inserted and removed with the power supply disconnected.</p>
	ANTENNA	Input for GOL148REA external antenna or rigid wire antenna supplied according to the operating frequency of the receiver module used.
	FLM - FL24 24 V $\overline{\text{=}}$ / 15W	<p>Flashing light. The pre-flashing settings can be selected from the third level menu AP \rightarrow WD and/or AP \rightarrow WC. To modify the operating mode of the LP output, refer to the selection BA \rightarrow FF.</p>
	ZENRS ZENPRS	<p>The control panel has a housing for modules of the ZENRS radio receiver type (433.92 MHz). Can be replaced with a module of the ZENPRS radio receiver type (868.35 MHz). The operating mode is selected via BC \rightarrow RM. When using slot-in radio boards, remove the RDX module. The display will show RV.</p> <p>! WARNING: the modules must be inserted and removed with the power supply disconnected.</p>
	MicroSD	<p>The control panel manages microSD cards for updating the firmware and for diagnostics and configuration storage/recovery via the in commands SF \rightarrow SV and SF \rightarrow RC.</p> <p>i NOTE: use a microSD with a maximum capacity:</p> <ul style="list-style-type: none"> • SD (Secure Digital) with capacities from 128 MB up to 2 GB • SDHC (Secure Digital High Capacity) with capacities from 4 GB up to 32 GB.

Output	Value of accessories	Description
	BIXMR2	<p>COM - Allows the operating configurations to be saved using the function SF → SV. The saved configurations can be recalled using the function SF → RC.</p> <p>COM - The storage module allows the remote controls to be saved in the memory. If the control panel is replaced, the storage module being used can be inserted in the new control panel.</p> <p> WARNING: the storage module must be inserted and removed with the power supply disconnected, and paying attention to the positioning direction.</p>
	FUTURE USE	

7. Jumper setting

Jumper	Description	OFF 	ON 
JR1	Display mode selection.	<p>Display mode The values and parameters present can be only displayed.</p>	<p>Maintenance mode The values and parameters present can be displayed and modified. Activated maintenance mode is indicated by the permanent lit on of the right-hand point on the display.</p>

Jumper	Description		
AUX1	Selection of power supply - auxiliary card 1.	AUX1 powered from 0-1.	AUX1 powered from 0-30.
AUX2	Selection of power supply - auxiliary card 2.	AUX2 powered from 0-1.	AUX2 powered from 0-30.

8. Using menus





NOTE: pressure on the keys may be quick (less than 2 s) or prolonged (longer than 2 s). Unless specified otherwise, quick pressure is intended. To confirm the setting of a parameter, prolonged pressing is necessary.

8.1 Switching the display ON and OFF

The procedure to switch on the display is as follows:



- press the key  ;
- the display functioning check starts  ;
- the first level menu is displayed  ;

The procedure to switch off the display is as follows:

- press the key  ;

NOTE: the display switches off automatically after 60 s of inactivity.

8.2 Navigation keys

- **UP and DOWN keys:** for scrolling through level one or two menus and through the list of possible values for a specific parameter.
- **ENTER key:** accesses the next menu level or the list of possible values for a menu parameter. Press and hold to confirm selection of the currently displayed parameter value.
- **ESC key:** go back to previous step in navigation.
- Simultaneous pressing of the keys **UP** and **ENTER** performs an opening command.

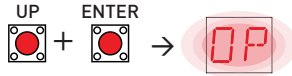

- Simultaneous pressing of the keys **DOWN** and **ENTER** performs a closing command.

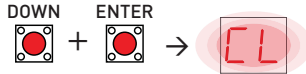

- Simultaneous pressing of the keys **UP** and **DOWN** performs a POWER RESET command. (interruption of the power supply and restart of the automation).



- Hold down the **UP** or **DOWN** key to begin fast menu scrolling.
- In some menus, the parameter measurement unit can be viewed by pressing the ENTER key once the value has been displayed.

Example: setting of 30 seconds for TC parameter.

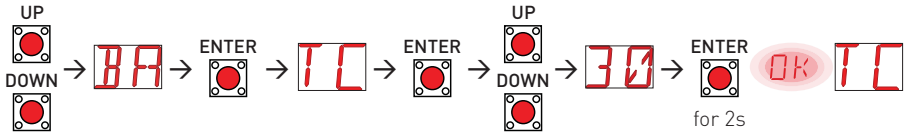

8.3 Menu map

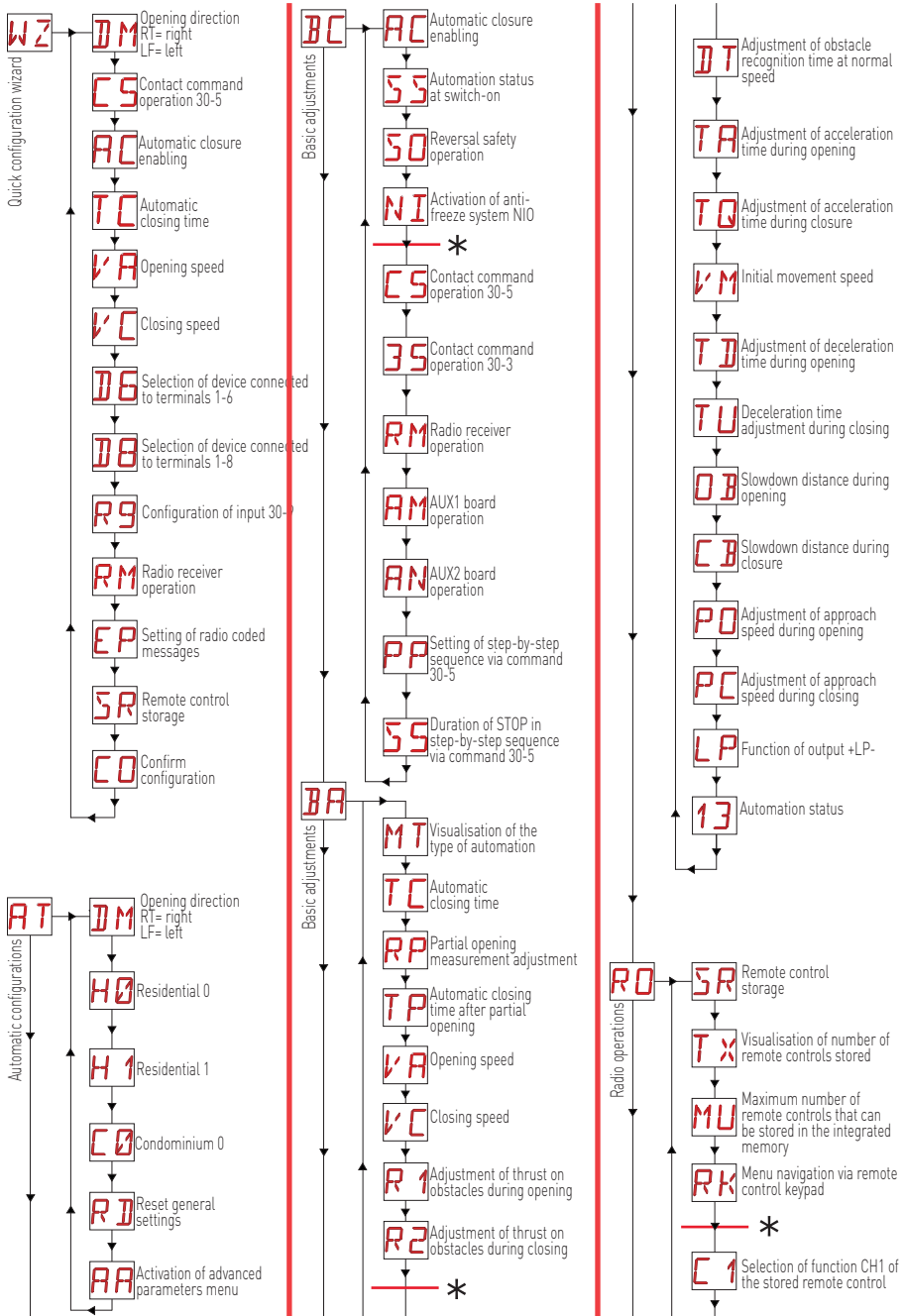

Special Function

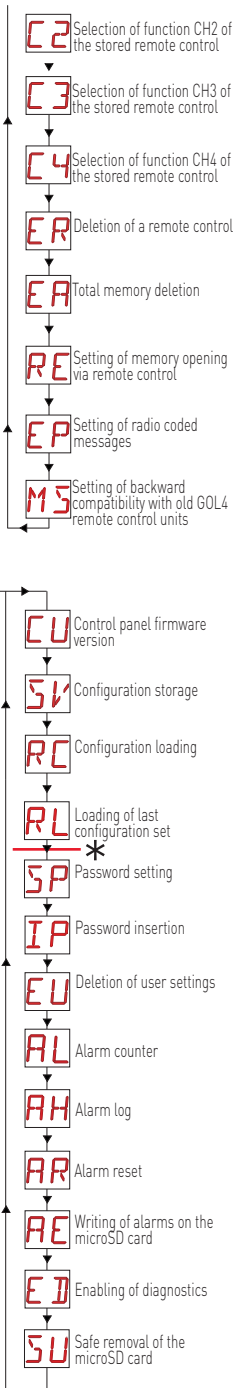

Cycle counters

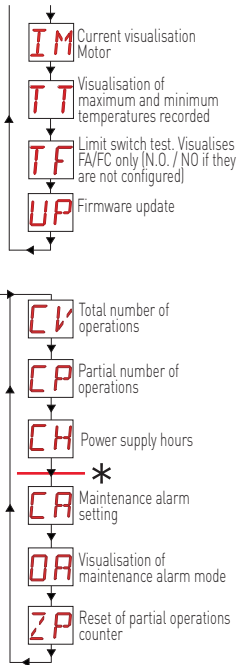

Energy management



Advanced parameters

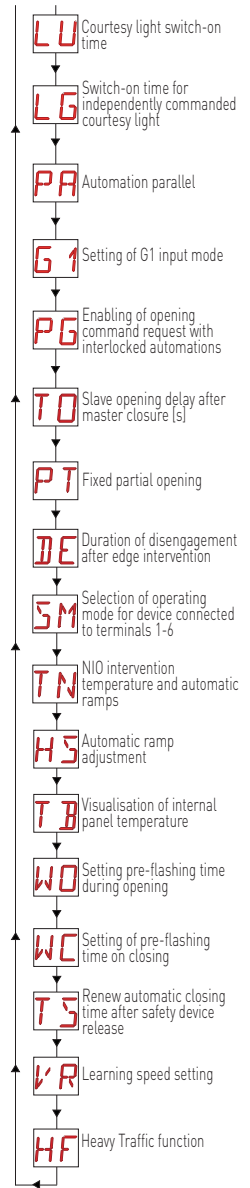
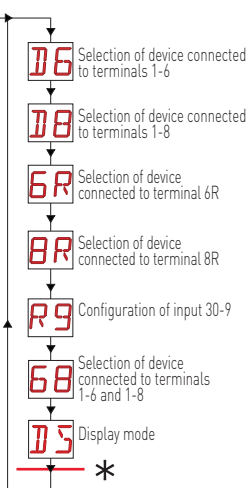

* Additional configurable parameters available with AT → AA is enabled.

9. Setting up product for first use

Use the WIZARD (WZ) wizard or the level two AT menu (automatic configuration) to set the product up rapidly with a quick configuration procedure [see parag. 9.2].

For detailed, customised configuration, use the main menus **BC**, **BA**, **RO**, **SF**, **CC**, **EM**, **AP**.

9.1 Wizard configuration menu (WZ)

To access the WZ quick configuration wizard menu:



Hold down the ENTER button for 2 seconds.

Once the message OK stops flashing, the first menu parameter:

WZ →  is displayed for 2 sec. **OK DM**

To set a parameter:

1. Press ENTER to access the configuration items.
2. Scroll UP/DOWN the possible options.
3. To confirm, press the ENTER button for 2 seconds. The selected value flashes and when it has finished, the next parameter appears.

DM →  →  **RT** →  for 2 sec. **OK CS**

List of parameters in WIZARD menu:

Display	Description
DM	DM - Selection of the direction mode <ul style="list-style-type: none"> • LF: opening towards left direction (output axis turns clockwise during opening) • RT: opening towards right direction (output axis turns counterclockwise during opening)
CS	C5 - Operation of command associated with contact 30-5 <ul style="list-style-type: none"> • 1-5: step-by-step (default) • 1-3: opening • NO: none • LG: courtesy light
AC	AC - Enabling of automatic closure <ul style="list-style-type: none"> • ON: enabled (default) • OF: disabled • 1-2: dependent on input 1-2 • hR: push-to-operate "dead man" closure (independently of setting of parameter R9) • hr: push-to-operate "dead man" closure, obliged until complete closure (independently of setting of parameter R9) <p>i NOTE: in hr mode if the closure command is removed before reaching the closed position limit switch, the door/gate re-opens automatically.</p>
TC	TC - Setting of automatic closing time [seconds] <p>[NOTE: only viewable visible if AC = ON was selected in previous step]</p> <ul style="list-style-type: none"> • from 0" to 59" with intervals of 1 second. • from 1' (default) to 2' with intervals of 10 seconds.
VA	VA - Opening speed. [cm/s] <p>CROSS20VEI</p> <ul style="list-style-type: none"> 10 - Minimum. 20 - Default. 30 - Maximum. <p>CROSS35VEI</p> <ul style="list-style-type: none"> 10 - Minimum. 20 - Default. 25 - Maximum.

WZ - Quick configuration wizard

VC	<p>VC - Closing speed. [cm/s]</p> <p>CROSS20VEI 10 - Minimum. 30 - Maximum.</p> <p>CROSS35VEI 10 - Minimum. 25 - Maximum.</p>
D6	<p>D6 - Selection of device connected to terminals 1-6</p> <ul style="list-style-type: none"> • NO: none. • SE: safety sensing edge (if contact 1-6 opens, 10 cm disengagement is implemented after stop). • S41: safety edge with safety test (if contact 1-6 opens, after the stop there is a disengagement of a duration depending on the selection AP → IE). • PH: photocells. • P41: photocells with safety test.
D8	<p>D8 - Selection of device connected to terminals 1-8</p> <ul style="list-style-type: none"> • NO: none. • SE: safety edge. • S41: safety edge with safety test. • PH: photocells. • P41: photocells with safety test.
R9	<p>R9 - Configuration of input 30-9</p> <ul style="list-style-type: none"> • NO: disabled. • 9P: open state of an input triggers permanent stop (default). • 9T: open state of an input triggers temporary stop. Once contact closes, automatic closure time (if enabled) is activated. • HR: automation operates in "operator present" mode if input is open.
RM	<p>RM - Radio receiver operation</p> <ul style="list-style-type: none"> • 1-5: opening (default) • 1-3: step-by-step
EP	<p>EP - AES (Encrypted Packet) reception setting</p> <p>If the possibility to receive coded messages is enabled, the control panel will be compatible with remote controls of the "AES-128 Encrypted" type.</p> <ul style="list-style-type: none"> • ON: enabled • OF: disabled
SR	<p>SR - Remote control storage</p> <p>When you press ENTER, SR starts to flash and you can associate the desired buttons. Once OK is displayed, SR starts to flash again and you can associate the next button. To quit, press ESC or ENTER for 2 seconds and go on to the next item.</p> <p>i NOTE: if NO flashes on the display, the remote control may already be stored.</p>
CO	<p>CO - Save Wizard settings</p> <p>Here you can save the parameters that have previously been set.</p> <ul style="list-style-type: none"> • YS: to save and perform a card RESET • NO: to quit without saving and go back to a blank screen (central part only) <p>i NOTE: the message CO and YS/NO sub-menus flash constantly.</p>

To save the configuration:

In the CO parameter select YS (yes) and press the ENTER button for 2 seconds.

After saving, a board POWER RESET cycle is performed automatically:

CO →  → YS →  for 2 sec. YS

To quit without saving changes:

Select the option NO for the parameter CO and then press and hold ENTER for 2 seconds

CO →  → NO →  for 2 sec. NO

Or: from any main parameter, press the ESC button for 2 seconds. Example:

EP →  for 2 sec. NO

NOTES:





- The set values are only stored on the card if they are saved using the CO parameter.
- The parameter CO and the YS/NO options flash constantly.
- After confirming a configuration parameter, the wizard moves on automatically to the next parameter.
- The UP/DOWN buttons may be used at any time, however, to scroll through parameters.
- There is no time limit for selecting and the wizard will not quit automatically.

9.2 Basic start-up example

 **WARNING:** the system must have sufficiently robust mechanical end stops and limit switches must be installed. The limit switches must be configured in stop mode.

 **WARNING:** if the control panel is used to replace an identical control panel which is faulty, the last automation configuration can be recovered by inserting the old control panel storage module into the new control panel and loading the last set configuration using the menu sequence SF → RL

 **WARNING:** before using the automation, make sure that the operating forces of the gate wings comply with the EN 12453:2017 standard and subsequent revisions.

1. Turn on the power.
2. Activate the WZ configuration wizard menu. Select the various parameters and set them as required for the application. Make sure that the opening direction parameter is correct (parameter JM).
3. Make a jumper for the safety contacts 1-6, 1-8 and 1-9, if they are not deactivated via menu parameters WZ → J6, J8, R9.
4. The limit switches must be adjusted so to take action slightly before reaching the desired opening and closing end positions. To adjust the limit switches, refer to the installation manual of the barrier in use.
5. Perform a complete opening ( +  keys) and closing ( + ) cycle and check that the automation performs the corresponding operation and stops after activating each limit switch (learning operation MQ).
6. Connect the safety devices after removing the jumpers 1-6, 1-8 and 1-9, or reactivating the corresponding inputs using the menu parameters AP → J6, AP → J8 and AP → R9. Make sure the various safety devices are operating correctly.

10. Frequently used menu sequences

10.1 Enabling the configurations

Step-by-step mode without automatic closure (residential use)

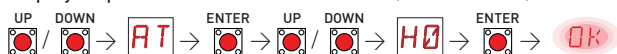

Step-by-step mode with automatic closure 1 min (residential use) [standard settings]

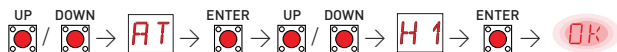

Opening mode with automatic closure 1 min (condominium use)

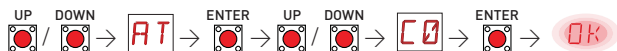

10.2 Adding remote controls

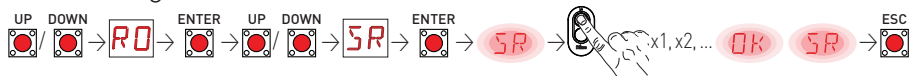

10.3 Configuring the NC contact safety devices

Example 1 - Configuring the photocells connected to terminals 1-8 and 1-6 [standard settings]

Set

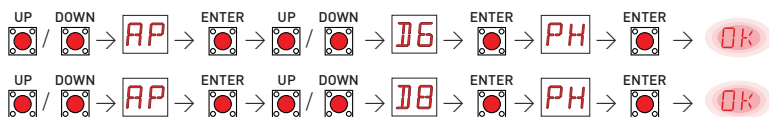

Example 2 - Configuring the safety edge with safety test simultaneously connected to terminals 1-6 and 1-8

Set



10.4 Configuring the resistive safety edges

Example 1 - Configuring the resistive safety edges connected to terminals 1-6R and 1-8R

Set

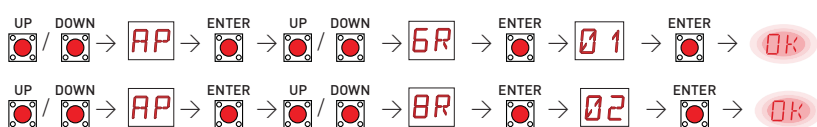

10.5 Synthetic diagram of operation



WARNING: the parameters shown in the figure must be adjusted to comply with exerted forces as outlined in EN 12453.

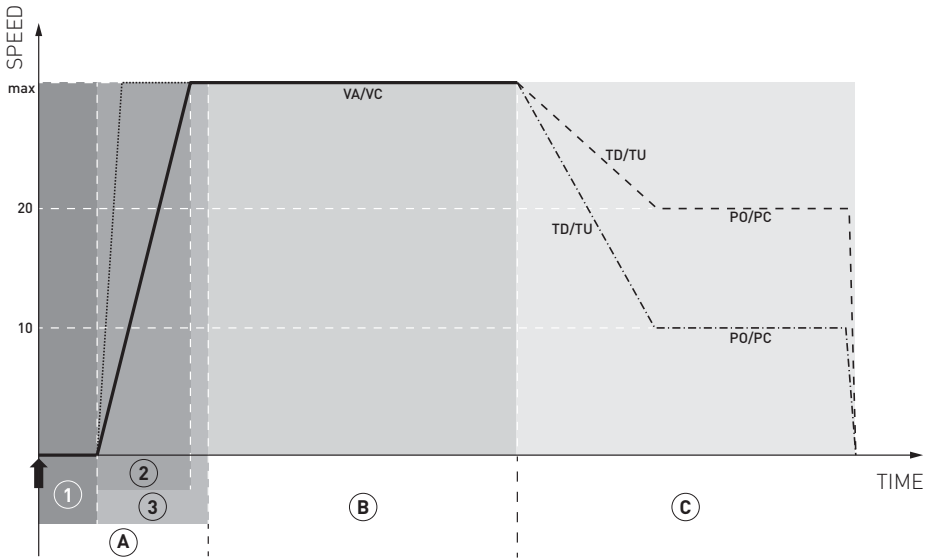

A START-UP PHASE

- 1 Pre-flashing time: parameters **WO** (opening) and **WC** (closure)
- 2 Acceleration time: acceleration time adjustment - **TA** (opening) and **TQ** (closure)
- 3 Start time (without detecting obstacles): fixed at 3 s (opening and closure)

B FULL SPEED PHASE

- Opening and closing speed: parameters **VA** (opening) and **VC** (closure).
- Opening and closing thrust: parameters **R1** (opening) and **R2** (closure).
- Thrust time: parameter **DT** (opening and closure).









C FINAL APPROACH PHASE

- Slowdown distance: parameters **OB** (opening) and **CB** (closure).
- Slowdown speed: parameters **TD** (opening) e **TU** (closure).
- Approach speed: parameter **P0** (opening) e **PC** (closure).
- Opening and closing thrust: parameters **R1** (opening) and **R2** (closure).
- Thrust time: parameter **DT** (opening and closure).



11. Configuration and settings menu

i **NOTE:** it is possible that, owing to the type of automation and control panel, certain menus are not available.

11.1 Main menu

Display	Description
	WZ - Quick configuration wizard Quick configuration menu
	AT - Automatic Configurations. The menu allows you to manage the automatic configurations of the control panel.
	BC - Basic Configurations. The menu allows you to display and modify the main settings of the control panel.
	BA - Basic Adjustments. The menu allows you to display and modify the main adjustments of the control panel. i NOTE: some settings require at least three operations before they are set correctly.
	RO - Radio Operations. The menu is used to manage the radio functions of the control panel.
	SF - Special Functions. The menu allows you to set the password and manage the special functions in the control panel (alarm management, diagnostics enabling, FW updating)..
	CC - Cycle Counter. The menu allows you to display the number of operations carried out by the automation and manage the maintenance interventions.
	EM - Energy Management. This menu may be used to view and modify energy saving settings and adjustments (Green Mode).
	AP - Advanced Parameters. The menu allows you to display and modify the advanced settings and adjustments of the control panel (limit switch mode, selection of devices connected to the terminals, disengagement duration adjustments, flashing light adjustments, etc.). i NOTE: some settings require at least three operations before they are set correctly.

From the main menu you can access the second level menu as follows:















- use the  and  keys to select the required function
- press  to confirm

After confirming the selection, you access the second level menu.

For each function of the main menu, there are also additional configurations that can be viewed by enabling the **AA** function (see the following paragraph).

i **NOTE:** to check if the parameters have actually been modified, quit the relative parameter and then access it again.
The modifications will take effect from the next operation.

11.2 Second level menu - AT (Automatic Configurations)

Display	Description	Selections available
	DM - Direction mode RT - open to the right LF - open to the left	
	H0 - Predefined setting, residential use 0. This selection loads predefined values for certain standard parameters: C5 - step-by-step control/opening operation: step-by-step RM - remote control operation: step-by-step AM - AUX1 plug-in board operation: step-by-step AN - AUX2 plug-in board operation: opening SS - selection of automation status at start-up: open	
	H1 - Predefined setting, residential use 1. This selection loads predefined values for certain standard parameters: AC - enabling of automatic closure: enabled TC - setting of automatic closing time: 1 minute C5 - step-by-step control/opening operation: step-by-step RM - remote control operation: step-by-step AM - AUX1 plug-in board operation: step-by-step AN - AUX2 plug-in board operation: opening SS - selection of automation status at start-up: closed	
	C0 - Predefined setting, condominium use 0. This selection loads predefined values for certain standard parameters: AC - enabling of automatic closure: enabled TC - setting of automatic closing time: 1 minute C5 - step-by-step control/opening operation: opening RM - remote control operation: opening AM - AUX1 plug-in board operation: opening AN - AUX2 plug-in board operation: opening SS - selection of automation status at start-up: closed	
	RD - Resetting to factory settings [FACTORY RESET]. ENTER  →  → ENTER  →  ⌀2 s	
	AA - Activation of additional configurable parameters for each function of the main menu. ENTER  →   ⌀2 s	
	After activation you can scroll through the third level menus. The third level menus are activated for 30 min.	

AT - Automatic configurations

11.3 Second level menu - BC (Basic Configurations)

BC - Basic configurations	Display	Description	Selections available
	AC	<p>AC - Enabling of automatic closure OF - Disabled ON - Enabled 1-2 - Dependent on input 30-2 hR - Push-to-operate "dead man" closure (independently of setting of parameter R9) hr - Push-to-operate "dead man" closure, obliged until complete closure (independently of setting of parameter R9)</p> <p>i NOTE: in hr mode if the closure command is removed before reaching the closed position limit switch, the door/gate re-opens automatically.</p>	<p>ON ON 1-2</p>
	SS	<p>SS - Selection of automation status at start-up. OP - Open. CL - Closed.</p> <p>Indicates how the control panel considers the automation at the time of switch-on, or after a POWER RESET command.</p>	<p>OP CL</p>
	SO	<p>SO - Enabling of reversal safety contact functioning. ON - Enabled. OF - Disabled.</p> <p>When enabled (ON) with the automation idle, if the contact 1-8 is open, all operations are prevented. When disabled (OF) with the automation idle, if the contact 1-8 is open, opening operations are permitted.</p>	<p>ON OF</p>
	NI	<p>NI - Enabling of NIO electronic anti-freeze system. ON - Enabled. OF - Disabled.</p> <p>When enabled (ON), it maintains the efficiency of the motor even at low ambient temperatures.</p> <p>i NOTE: for correct operation, the control panel must be exposed to the same ambient temperature as the motors.</p> <p>The intervention temperature for the NIO system can be set by selecting AP → TN.</p>	<p>ON OF</p>

11.3.1 Additional BC level parameters that can be configured (available with **AT** → **AA** enabled)

BC - Basic configurations	Display	Description	Selections available	
	CS	C5 - Operation of command associated with contact 30-5 (wake-up from stand-by) 1-3 - Opening 1-5 - Step-by-step LG - Courtesy light command NO - Input 5 disabled	1-3	1-5
	35	35 - Operation of command associated with contact 30-3 1-3 - Opening 1-5 - Step-by-step LG - Courtesy light command NO - Input 3 disabled	1-3	1-5
	RM	RM - Radio receiver operation 1-3 - Opening 1-5 - Step-by-step	1-3	1-5
	AM	AM - Operation of AUX1 plug-in control board 1-3 - Opening 1-5 - Step-by-step NO - Disabled	1-3	1-5
	AN	AM - Operation of AUX2 plug-in control board 1-3 - Opening 1-5 - Step-by-step NO - Disabled	1-3	1-5
	PP	PP - Setting of step-by-step sequence via command 30-5 ON - Opening-Stop-Closing-Stop-Opening OF - Opening-Stop-Closing-Opening	ON	OF
	SS	S5 - Duration of STOP in step-by-step sequence via command 30-5 ON - Permanent (automatic closure is excluded until a new command is given) OF - Temporary (the automatic closure timer intervenes, if enabled)	ON	OF

11.4 Second level menu - BA (Basic Adjustment)

Display	Description	Selections available
MT	MT - Display of type of automation. 20 - Motor with 2000 kg capacity (CROSS20VEI). 35 - Motor with 3500 kg capacity (CROSS35VEI). NOTE: this parameter is DISPLAY only.	20 35
TC	TC - Setting of automatic closing time. [s] It is set with different intervals of sensitivity. - from 0s to 59s in 1-second steps - from 1 min to 2 min in 10-second steps.	00 59 11 21 1'00"
RP	RP - Adjustment of partial opening measurement. [%] Adjusts the percentage of operation in relation to the total opening of the automation. 10 - Minimum. 99 - Maximum.	10 99 50
TP	TP - Setting of automatic closing time after partial opening. [s] It is set with different intervals of sensitivity. - from 0s to 59s in 1-second steps - from 1 min to 2 min in 10-second steps.	00 59 11 21 30
VA	VA - Opening speed. [cm/s] CROSS20VEI 10 - Minimum. 30 - Maximum. CROSS35VEI 10 - Minimum. 25 - Maximum.	CROSS20VEI 10 30 20 CROSS35VEI 10 25 20
VC	VC - Closing speed. [cm/s] CROSS20VEI 10 - Minimum. 30 - Maximum. CROSS35VEI 10 - Minimum. 25 - Maximum.	CROSS20VEI 10 30 20 CROSS35VEI 10 25 20
R1	R1 - Adjustment of the thrust during OPENING [A] Stops the movement with disengagement and alarm DD if the motor current exceeds the threshold for a time greater than parameter DT ; the next operation will be carried out in learning mode. CROSS20VEI 3.5 - Minimum. 6.0 - Maximum. CROSS35VEI 4.5 - Minimum. 9.9 - Maximum.	CROSS20VEI 3.5 6.0 4.5 CROSS35VEI 4.5 9.9 6.0

BA - Basic adjustment

Display	Description	Selections available
BA - Basic adjustment R2	R2 - Adjustment of the thrust during CLOSURE [A] Stops the movement with disengagement and alarm OE if the motor current exceeds the threshold for a time greater than parameter DT; the next operation will be carried out in learning mode. CROSS20VEI 3.5 - Minimum. 6.0 - Maximum.	CROSS20VEI 3.5 ▶ 6.0 <u>4.5</u>
	CROSS35VEI 4.5 - Minimum. 9.9 - Maximum.	CROSS35VEI 4.5 ▶ 9.9 <u>6.0</u>

NOTE: make adjustments gradually and only after performing at least three complete operations to allow the control panel to be set correctly and detect any friction during operations.

11.4.1 Additional BA level parameters that can be configured (available with **AT** → **AA** enabled)

Display	Description	Selections available
BA - Basic adjustment DT	DT - Thrust time duration. [s] Value relating to parameters R1 and R2 [s]. CROSS20VEI and CROSS35VEI 0.5 - Minimum. 5.0 - Maximum.	CROSS20VEI 0.5 ▶ 5.0 <u>3.0</u>
		CROSS35VEI 0.5 ▶ 5.0 <u>4.0</u>
TA	TA - Adjustment of acceleration time during opening. [s] 0,5 - Minimum. 9,9 - Maximum.	0.5 ▶ 9.9 <u>3.0</u>
TQ	TQ - Adjustment of acceleration time during closing. [s] 0,5 - Minimum. 9,9 - Maximum.	0.5 ▶ 9.9 <u>3.0</u>
VM	VM - Initial movement speed. [cm/s] 10 - Minimum. 20 - Maximum.	10 ▶ 20 <u>10</u>
TD	TD - Adjustment of deceleration time during opening. [%] Adjusts the deceleration ramp slope. 10 - Minimum. 99 - Maximum.	10 ▶ 99 <u>60</u>
TU	TU - Adjustment of deceleration time during closing. [%] Adjusts the slope of the deceleration ramp during closure. 10 - Minimum. 99 - Maximum.	10 ▶ 99 <u>60</u>

BA - Basic adjustment

Display	Description	Selections available
OB	OB - Adjustment of slowdown distance during opening. [cm] Indicates the distance from the end of the opening stroke where the deceleration ramp begins. 05 - Minimum. 99 - Maximum.	05 99 80
CB	OB - Adjustment of slowdown distance during closing. [cm] Indicates the distance from the end of the closing stroke where the deceleration ramp begins. 05 - Minimum. 99 - Maximum.	05 99 80
PO	PO - Adjustment of approach speed during opening. [cm/s] Indicates the speed from the end of the deceleration ramp to the end of the opening stroke. 10 - Minimum. 20 - Maximum. NOTE: gradually increase the approach speed if there is a series of quick vibrations (chattering) in heavy gates installed with a slight incline.	10 20 10
PC	PC - Adjustment of approach speed during closing. [cm/s] Indicates the speed from the end of the deceleration ramp to the end of the closing stroke. 10 - Minimum. 20 - Maximum.	10 20 10
LP	LP - LP output operating mode See tab. 11.4.1	00 14 01
13	13 - 13 output operating mode See tab. 11.4.1	00 14 03



NOTE: make adjustments gradually and only after performing at least three complete operations to allow the control panel to be set correctly and detect any friction during operations.

BA - Basic adjustments

Table 11.4.1> Operating modes of configurable outputs 13 and LP (parameters 13 and LP)

	Modalities to the manoeuvring phase						
	Entrance closed	Open prelamp	Opening stroke	Open entrance	Closed prelamp	Closing stroke	CB* Entrance closed
00: Courtesy light							
01: ON-OFF flashing light							
02: Permanent flashing light (auto-flashing)							
03: Proportional indicator light for open gate							
04: Indicator light for open gate							
05: Gate stationary and closed indicator light							
06: Gate stationary and fully open indicator light							
07: Gate moving indicator light							
08: Gate opening indicator light							
09: Gate closing indicator light							
10: Red light control / proportional shaft lights							
11: Red light flashing control with closed gate/door and proportional input during the operation							
12: Electromagnetic lock control - QIKAFE							
ON: Output always active							
LP-13 special operating mode							
13: STOP-signalling / safety switching							
14: Maintenance alarm							





* CB: Deceleration distance on closing
 ** LU: Courtesy light switch-on time

11.5 Second level menu - R0 (Radio Operations)

R0 - Radio operations

Display	Description	
SR	<p>SR - Remote control storage. You can directly access the Remote control storage menu even with the display turned off, but only with the Display visualisation mode option set to 00 or 03: - for transmitting a remote control not present in the memory; - for transmitting an unstored channel of a remote control already present in the memory.</p>	
	<p>WARNING: if the display shows NO flashing, the remote control may already be stored.</p>	
TX	<p>TX - Visualisation of counter showing remote controls stored. ENTER → 00 → 16 → 16 radiocomandi [esempio]</p>	
MU	<p>MU - Indication of maximum number of remote controls that can be stored in the integrated memory. You can store a maximum of 100 or 200 remote control codes. ENTER → 10 or 20 → ENTER → OK</p> <p>20 - 200 remote controls that can be stored. 10 - 100 remote controls that can be stored.</p> <p>WARNING: selecting MU → 20 (200 remote controls), the configurations U 1 and U 2 saved with the SF → SV command will be lost. This also applies for the last configuration reloaded with RL. In addition, new configurations cannot be saved on U 1 and U 2.</p>	<p>Selections available</p> <div style="font-size: 2em; color: red; text-align: center;"> 20 10 </div>
RK	<p>RK - Menu navigation using remote control keyboard. ON - Enabled OF - Disabled</p> <p>With the display turned off, quickly type in the sequence of keys ③ ③ ② ④ ① from the stored remote control you want to use. Make sure all the CH keys are stored.</p> <p>WARNING: during navigation with a remote control keyboard ALL the stored remote controls are inactive.</p>	<div style="font-size: 2em; color: red; text-align: center;"> ON OF </div>

11.5.1 Additional configurable RO level parameters available with **AT** → **AA** enabled

Display	Description	Selections available
C1 C2 C3 C4	C1, C2, C3, C4 - Selection of CH1, CH2, CH3, CH4 function of stored remote control. NO - No setting selected 1-3 - Opening command 1-4 - Closure command 1-5 - Step-by-step control P3 - Partial opening command LG - Courtesy light on/off command 1-9 - STOP command If even just one (any) CH key of the remote control is stored, the opening or step-by-step command is implemented.	NO 1-3 1-4 1-5 P3 LG 1-9
	i NOTE: the 1-3 (opening) and 1-5 (step-by-step) options are available as alternatives, and depend on the selection BC → RM .	
	If 2-4 CH keys of a single remote control are stored, the functions matched in the factory with the CH keys are as follows:	
	<ul style="list-style-type: none"> • CH1 = opening/step-by-step command; 1-3, 1-5 (depending on parameter RM); • CH2 = partial opening command; P3; • CH3 = command to switch on/off the courtesy light; LG; • CH4 = STOP command; 1-9; 	
ER	ER - Deletion of a single remote control. ENTER  → ER →  ⌀2 s	
EA	EA - Total memory deletion. ENTER  → EA → ENTER  → OK ⌀2 s ⌀2 s	
RE	RE - Setting memory opening from remote control. OF - Disabled ON - Enabled. When enabled (ON), the remote programming is activated. To store new remote controls without using the control panel, refer to the remote control instructions. i NOTE: make sure you do not accidentally memorise unwanted remote controls.	ON OF
EP	EP - Setting the coded area messages If the possibility to receive coded messages is enabled, the electronic panel will be compatible with remote controls of the "ENCRYPTED" type.	ON OF
MS	MS - Backward compatibility setting with older generation GOL4 remote controls. OF - Compatibility with old generation GOL4 and new ZEN remote controls. ON - Compatibility with ZEN series remote controls i NOTE: MS=ON is recommended if only ZEN series remote controls are used on the system.	

RO - Radio operations

11.6 Second level menu - SF (Special Functions)

SF - Special Functions		Display	Description	Selections available
		CU	<p>CU - Visualising the control panel logic and power firmware versions.</p> <p>ENTER → → R. → 1.1 → .00 → -M → 1.6</p> <p>Logic firmware 1.1.00 Power firmware 1.6</p>	
SV	<p>SV - Saving user configuration on control panel storage module and/or on microSD card.</p> <p>ENTER → → U 1 → / → U 2 → → (2 s)</p> <p>By selecting RO → MU → 10 you can save up to 2 personalised configurations in memory positions U 1 and U 2 only with the storage module present on the control panel. With a microSD on the control panel, up to 2 personalised configurations can be saved in positions D 1 and D 2.</p> <p>WARNING: if RO → MU → 20 is selected, no user configuration can be saved on U 1 and U 2. WARNING: if the display shows flashing, the storage module or microSD card may not be present.</p>	<p>U 1</p> <p>U 2</p> <p>D 1</p> <p>D 2</p>		
RC	<p>RC - Configuration loading.</p> <p>ENTER → → 0 1 → / → U 2 → → (2 s)</p> <p>The user configurations saved previously can be loaded - U 1 and U 2 on the storage module of the control panel, or D 1 and D 2 on the microSD card.</p>	<p>U 1</p> <p>U 2</p> <p>D 1</p> <p>D 2</p>		
RL	<p>RL - Loading of last configuration set.</p> <p>ENTER → → → (2 s)</p> <p>The control panel automatically saves the last configuration set, and keeps it memorised in the storage module or microSD card. In the event of a fault or the replacement of the control panel, the last configuration of the automation can be restored by inserting the storage module or microSD card and loading the configuration in question.</p>			

11.6.1 Additional configurable SF level parameters available with **AT** → **AA** enabled

Display	Description
SP	<p>SP - Setting the password. ENTER → 01 → UP / DOWN → 07 → ENTER → OK <small>[example] ⊙ 2 s</small></p> <p>i NOTE: this can only be selected when the password is not set.</p> <p>Setting the password prevents unauthorised personnel from accessing selections and adjustments. You can delete the set password by selecting the sequence JR1=ON, JR1=OFF, JR1=ON.</p>
IP	<p>IP - Inserting the password. ENTER → 01 → UP / DOWN → 07 → ENTER → OK <small>[example] ⊙ 2 s</small></p> <p>i NOTE: this can only be selected when the password is not set.</p> <p>When the password is not inserted, you can access the display mode regardless of the selection made with JR1. When the password is inserted, you can access in maintenance mode.</p>
EU	<p>EU - Deletion of user configurations and last configuration set in the storage module. ENTER → EU → ENTER → OK <small>⊙ 2 s ⊙ 2 s</small></p>
AL	<p>AL - Alarm counter. Used to view, in sequence, the counters of alarms that have been triggered at least once (alarm code + number of times triggered). With UP and DOWN, you can scroll through all the counters and see all the alarms recorded.</p>
AH	<p>AH - Alarm log. Used to view, in sequence, alarms that have been triggered (up to a maximum of 20). With UP and DOWN, you can scroll through the entire alarm log. The display shows the alarm number and code, alternated. The highest number corresponds to the most recent alarm and the lowest number (0) corresponds to the oldest alarm.</p>
AR	<p>AR - Alarm reset. Resets all the alarms in the memory (counters and log). ENTER → OK <small>⊙ 2 s</small></p> <p>i NOTE: when the installation has been completed, you are advised to delete the alarms in order to facilitate future checks.</p>
AE	<p>AE - Writing of alarms on microSD card. Creates a text file on the microSD memory, containing some information about the control panel: the firmware version, operation counters, hour counters, configuration parameters, alarms. ENTER → OK <small>⊙ 2 s</small></p> <p>i NOTE: the alarm counters and alarm log are associated with the number of the operation that was in progress when they were triggered.</p>

SF - Special Functions

Display	Description
ED	<p>ED - Enabling of diagnostics Enables the periodic saving of data on the microSD card, for diagnostic use. NO - Disabled. 01 - Internal use [DO NOT USE]. 02 - List of events on microSD card.</p>
SU	<p>SU - Safe removal of the microSD card.</p>
IM	<p>IM - Motor current display If a dot appears to the right of the displayed figures, this means that the Power Boost is activated. E.g. 10. = 10 A current with power boost activated. The Power Boost (available only for CROSS20VEI) is automatically activated when more power is required from the motor.</p>
TT	<p>TT - Display of min/max temperatures recorded - press for 2 sec to reset the values - minimum value with RH limit switch active</p>
TF	<p>TF - Limit switch test Only FA/FC are displayed when the relative limit switches are configured and active. If the limit switches are active but not configured: - FA= N.O. (both limit switches active) - FC= NO (no limit switch active)</p>
UP	<p>UP - Firmware update. The FW update can be carried out using USBPROG (possible from card version 0.4). Via microSD card the procedure is:</p>

11.7 Second level menu - CC (Cycles Counter)

Display	Description
CV	CV - Display of total operations counter. ENTER → 00 → 01 → 82 → 182 operations [example]
CP	CP - Display of partial operations counter. ENTER → 00 → 07 → 16 → 716 operations [example]
CH	CH - Display of power supply hour counter. ENTER → 00 → 02 → 15

11.7.1 Additional configurable CC level parameters available with **AT** → **AA** enabled

Display	Description	Selections available
CA	CA - Setting the maintenance alarm (factory setting - alarm deactivated: 0.0 00. 00). You can set the required number of operations (regarding the partial operations counter) for signalling the maintenance alarm. When the set number of operations is reached, the alarm message appears on the display Example: Setting the maintenance alarm after 700 operations (00) (07) (00)	
	ENTER → 00 → UP / DOWN → 00 → ENTER → 00 → UP / DOWN → 07 → ENTER → 00 → ENTER ∅ 2 s	
OA	OA - Selecting maintenance alarm display mode. 00 - Visualisation on display (alarm message ✓0). 01 - Visualisation on flashing light (with the automation idle, 4 flashes are made and then repeated every hour) and on display (alarm message ✓0). 02 - Visualisation on "open gate" indicator light (with the automation closed, 4 flashes are made and then repeated every hour) and on display (alarm message ✓0).	
ZP	ZP - Reset of partial operations counter. ENTER → OK ∅ 2 s For correct functioning, you are advised to reset the partial operations counter: <ul style="list-style-type: none"> - after maintenance work; - after setting the maintenance alarm interval. 	

11.8 Second level menu - EM (Energy Management)

EM - Energy Management	Display	Description	Selections available
EM - Energy Management	ES	<p>ES - "Green Mode" (energy-saving) (disconnection of accessories connected to terminals 0-1 when the automation is in standby).</p> <p>ON - Enabled (the red point on the right of the display flashes every 5 s. Outputs +LP- and 30-13 are not managed in low-consumption mode).</p> <p>OF - Disabled.</p> <p>Power supply disconnection mode is activated after 15 s with the gate closed, or when the gate is idle and automatic closure is not enabled.</p> <p>The automation resumes normal operation when a command is received from the radio board (ZENRS-ZENPRS) or after a contact 30-5, 30-20, 30-3 or 30-4.</p> <p>WARNING: if you use accessories that need to remain powered even with Green Mode enabled (e.g. LAN4 or GOPAV), set the jumper AUX1-2 relating to the slot used on power supply 0-30.</p>	<p>ON</p> <p>OF</p>

11.9 Second level menu - AP (Advanced Parameters)

AP - Advanced Parameters	Display	Description	Selections available
AP - Advanced Parameters	D6	<p>D6 - Selection of device connected to terminals 1-6.</p> <p>NO - None.</p> <p>SE - Safety edge (if contact 1-6 opens, after the stop there is a disengagement of a duration depending on the selection AP → DE).</p> <p>S41 - Safety edge with safety test (if contact 1-6 opens, after the stop there is a disengagement of a duration depending on the selection AP → DE).</p> <p>PH - Photocells.</p> <p>P41 - Photocells with safety test.</p>	<p>NO SE</p> <p>S41 PH</p> <p>P41</p>
AP - Advanced Parameters	D8	<p>D8 - Selection of device connected to terminals 1-8.</p> <p>NO - None.</p> <p>SE - Safety edge.</p> <p>S41 - Safety edge with safety test.</p> <p>PH - Photocells.</p> <p>P41 - Photocells with safety test.</p>	<p>NO SE</p> <p>S41 PH</p> <p>P41</p>
AP - Advanced Parameters	6R	<p>6R - Device connected to terminal 6R</p> <p>NO - None.</p> <p>01 - Stop with disengagement during both opening and closing operations. (Once the idle resistance value (8.2K) has been reset, the operation is resumed).</p> <p>02 - During closure, a significant variation in the resistance value above or below the idle resistance value (8.2 kΩ) stops and reverses the movement. When the automation is stationary, all operations are disabled.</p>	<p>NO 02</p> <p>01</p>
AP - Advanced Parameters	8R	<p>8R - Device connected to terminal 8R</p> <p>NO - None.</p> <p>01 - Stop with disengagement during both opening and closing operations. (Once the idle resistance value (8.2K) has been reset, the operation is resumed).</p> <p>02 - During closure, a significant variation in the resistance value above or below the idle resistance value (8.2 kΩ) stops and reverses the movement. When the automation is stationary, all operations are disabled.</p>	<p>NO 02</p> <p>01</p>
AP - Advanced Parameters	R9	<p>R9 - Configuration of input 30-9.</p> <p>NO - Disabled.</p> <p>9P - Open state of an input triggers permanent stop.</p> <p>9T - The opening of the input causes a temporary stop. When the contact closes, the automatic closure time is activated (if enabled).</p> <p>HR - With the input open, the automation works in "hold-to-run" mode.</p>	<p>NO 9T</p> <p>9P HR</p>

Display	Description	Selections available
68	68 - Selection of the device simultaneously connected to terminals 1-6 and 1-8. NO - None. SE - Safety edge. S41 - Safety edge with safety test. If different from NO, the simultaneous opening of inputs 1-6 and 1-8 causes: - movement stop and reversal during a closing operation. - stop and disengagement of a duration depending on the selection AP → DE during an opening operation.	NO SE S41
	DS - Setting of display visualisation mode. 00 - No information displayed. 01 - Commands and safety devices with radio test (see paragraph 9.2). Display of countdown to automatic closing time. 02 - Automation status (see paragraph 13.1). 03 - Commands and safety devices (see paragraph 13.2). i NOTE: the setting 01 allows you to see when a radio transmission is received, for range checks.	00 01 02 03

i **NOTE:** make adjustments gradually and only after performing at least three complete operations to allow the control panel to be set correctly and detect any friction during operations.

11.9.1 Additional AP level parameters that can be configured (available with **AT** → **AA** enabled)

Display	Description	Selections available
LU	LU - Setting the courtesy light switch-on time (s). To enable this parameter, set at least one of the selections LP → 00 or 13 → 00 as a courtesy light. It is set with different intervals of sensitivity. NO - Disabled. from 1s to 59s in 1-second steps from 1 min to 2 min in 10-second steps from 2 min to 3 min in 1-minute steps ON - Permanently enabled (switched off via remote control). i NOTE: the courtesy light switches on at the start of each operation	NO 01 159 1' 2' 2' 3' ON
	LG - Switch-on time for independently commanded courtesy light. [s] To enable this parameter, set at least one of the selections LP → 00 or 13 → 00 as a courtesy light. It is set with different intervals of sensitivity. NO - Disabled from 1s to 59s in 1-second steps from 1 min to 2 min in 10-second steps from 2 min to 3 min in 1-minute steps ON - Switched on and off with remote control. i NOTE: the switching on of the light does not depend on the start of an operation, but can be commanded separately using the special remote control key.	NO 01 159 1' 2' 2' 3' ON
PA	PA - Automation parallel (see examples of applications) Sets the type of automation parallel 01 - Simultaneous automations 02 - Interlocked automations with one-way or two-way transit, without presence detection 03 - Interlocked automations with one-way transit, with presence detection	01 02 03

AP - Advanced Parameters

Display	Description	Selections available
G 1	G1 - Setting the G1 input mode N0 - Absent 1-3 - Opening 1-5 - Step-by-step 1-6 - Safety stop 1-8 - Input 1-8 (safety reopening) dependent on setting AP → TS . SY - Synchronism input	N01-3 <u>1-51-6</u> 1-8SY
PG	PG - Enabling interlocked automation opening control request (see examples of applications). ON - Enabled OF - Disabled When enabled (ON), it requests the automation 1 opening command if automation 2 is engaged in completing the operation.	ONOF <u>OF</u>
TO	TO - Slave opening delay after master closure for interlocked automations with PA= 02 or PA= 03.	0030 <u>15</u>
PT	PT - Fixed partial opening. ON - Enabled. OF - Disabled. If ON, a partial opening command given on the partial opening position is ignored. With contact 30-20 closed (for example with the timer or manual selector), the gate will partially open. If it is then fully opened (command 30-3) and reclosed (even with automatic closing), it will stop at the partial opening position.	ONOF <u>OF</u>
DE	DE - Disengagement duration if an edge is triggered. [s] Regulates the duration of the disengagement when an edge (active or passive) is triggered during opening or closure. In the case of gates with two wings, it acts on both wings. 00 - Disable.	0.02.0 <u>1.0</u>
SM	SM - Selection of operating mode of device connected to terminals 1-6 00 - During an opening or closing manoeuvre, the opening of I-6 safety contact stops the movement. When the contact is closed again the interrupted manoeuvre does not resume, and the operator waits for an external command or performs an automatic closure if enabled. 01 - During an opening or closing manoeuvre, the opening of I-6 safety contact stops movement. When the contact is closed again the interrupted manoeuvre is resumed. 02 - During an opening or closing manoeuvre, the opening of I-6 safety contact stops the movement. When the contact is closed again a total opening manoeuvre is performed. 03 - During a closing manoeuvre, the opening of I-6 safety contact reverses the movement. During the opening manoeuvre, the behaviour of safety contact I-6 has no effect 04 - During an opening manoeuvre, the opening of I-6 safety contact stops the movement. When the contact is closed again, the interrupted opening manoeuvre is resumed. During the closing manoeuvre, the behaviour of safety contact I-6 has no effect 05 - During a closing manoeuvre, the opening of I-6 safety contact stops the movement. If I-6 contact is closed again within 1 second, a total opening manoeuvre is performed. Contrariwise, if it is closed again later, no further opening manoeuvre is performed and the operator waits for and external command or for an automatic closure if enabled. During an opening manoeuvre, the opening of I-6 safety contact stops the movement. When the contact is closed again the interrupted manoeuvre is not resumed, and the operator waits for and external command or performs an automatic closure if enabled.	0001 <u>0001</u> 0203 0405
i	NOTE: in all the cases described above, after a movement stop event a disengagement is performed if DE → SE/54 .	

AP - Advanced Parameters

Display	Description	Selections available
TN	<p>TN - Setting of intervention temperature for NIO electronic anti-freeze system and automatic HS ramps [°C]</p> <p>This value does not refer to the ambient temperature, but to the internal control panel temperature.</p> <p>i NOTE: With TT parameter the highest/lowest temperature reached by the control unit can be checked.</p>	-- 950 20
HS	<p>HS - Automatic ramp adjustment.</p> <p>ON - Enabled. OF - Disabled.</p> <p>When enabled (ON), at low ambient temperatures the acceleration time TA diminishes to the minimum value.</p> <p>i NOTE: for correct operation, the control panel must be exposed to the same ambient temperature as the motors.</p>	ON OF
TB	<p>TB - Permanent display of the internal control panel temperature. [°C]</p>	ON OF
WO	<p>WO - Setting of pre-flashing time during opening. [s]</p> <p>Adjustment of the lead time for the switch-on of the flashing light, in relation to the start of the opening operation from a voluntary command.</p> <p>00 - Minimum 05 - Maximum</p>	00 05 00
WC	<p>WC - Setting of pre-flashing time on closing. [s]</p> <p>Adjustment of the lead time for the switch-on of the flashing light, in relation to the start of the closing operation from a voluntary command.</p> <p>00 - Minimum 05 - Maximum</p>	00 05 00
TS	<p>TS - Setting of renewal of automatic closing time after safety device release. [%]</p> <p>00 - Minimum 99 - Maximum</p>	00 99 99
VR	<p>VR - Setting of learning speed. [cm/s]</p> <p>10 - Minimum 20 - Maximum</p>	10 20 10
HF	<p>HF - Heavy Traffic function</p> <p>When activated, this function automatically sets the automatic reclosure time to 190 s.</p> <p>00 - Not activated</p> <p>01 - Reduces motor overheating: it is activated if, in the last 10 minutes, the motor is in operation for:</p> <ul style="list-style-type: none"> > 3 minutes for CROSS20VEI > 5 minutes for CROSS35VEI. <p>It is deactivated when the motor is in operation for less than:</p> <ul style="list-style-type: none"> 2' 30" for CROSS20VEI 4' 30" for CROSS35VEI. <p>02 - Reduces the mechanical stress caused by reversal: it is activated when the number of reversals without touching the closed limit switch is > 3; it is deactivated when the automation touches the closed limit switch.</p> <p>03 - Applies criterion 01 or criterion 02.</p>	000 1 020 3

12. Diagnostics



12.1 Data Logging integrated in the card

The Ditec LCU43A / LCU43B control panel is equipped with an internal system which allows the installer to check whether any alarms have been triggered, see how many times each alarm has been triggered, and view a log of the last twenty alarms.

12.1.1 Alarm counter

With the third level menus enabled (**AT** → **AA**), go to **SF** → **AL** to see all the alarms recorded by the electronic panel. The display alternately shows the alarm code and the number of times it was triggered.



Example: **M0** _ **05** _ **M0** _ **05** _

Use the  and  keys to scroll through the entire list of alarm counters.

12.1.2 Alarm log

With the third level menu enabled (**AT** → **AA**), go to **SF** → **AH** to see the alarm log (the last 20 alarms recorded). The display shows the alarm number and code, alternated. The highest number corresponds to the most recent alarm and the lowest number corresponds to the oldest alarm.

Example: **-1** _ **M0** _ **-1** _ **M0** _

Use  and  to scroll through the alarm log.

12.1.3 Exporting information on the microSD

With the third level menus enabled (**AT** → **AA**), the microSD card inserted and the automation stationary, go to **SF** → **AE** to export all the electronic panel parameters on the microSD. The LCU43A e LCU43B_INFO.txt text file created on the microSD contains all the alarm counters, a log showing the last twenty alarms, the operating statistics and the complete configuration of the electronic panel.

By inserting the microSD in a PC and opening the file LCU43A_INFO_.txt with the Ditec software, you can view all the electronic panel data.



NOTE: when the installation is complete, you are advised to delete the internal data logging.

12.2 Extended data logging on microSD

The Ditec LCU43A / LCU43B control panel can record every event and/or alarm for every operation performed.

This is made possible by leaving a microSD inserted in the relative connector and then, with the third level menus enabled (**AT** → **AA**), setting **SF** → **E J** → **02**.

In this way, at the end of every operation the electronic panel will save all the events recorded up to that moment on the microSD (in the LCU43A / LCU43B .log file in the LCU43A_LOG / LCU43B_LOG folder).

The recorded logs can be viewed by inserting the microSD in a PC and opening the LCU43A / LCU43B .log file using the Amigo Ditec software.

This is an example of the visualisation of recorded events:

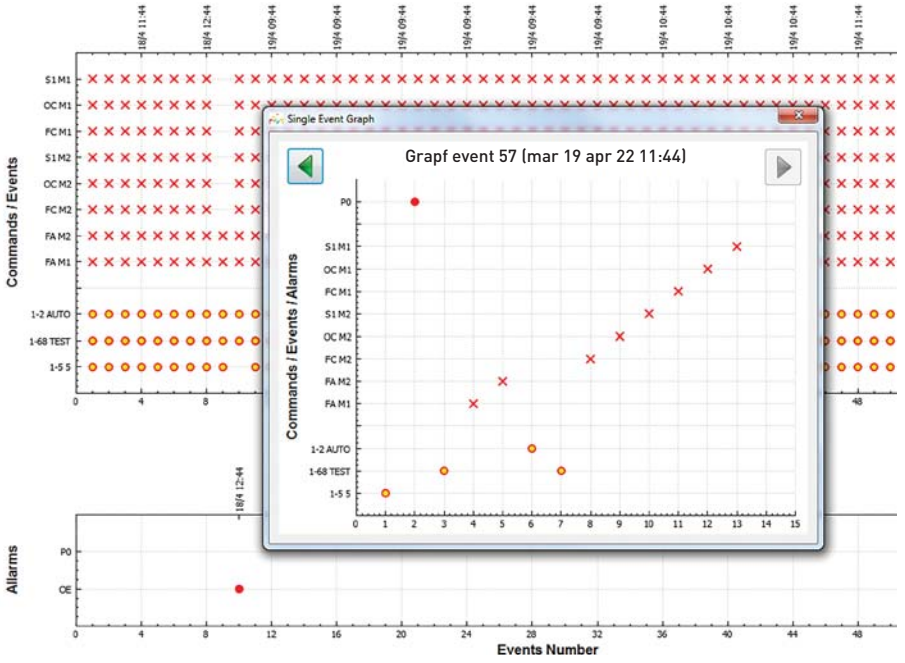

13. Examples of application for parallel automations

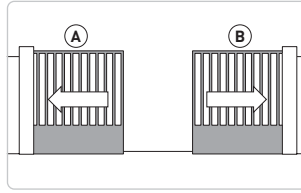

The parallel connection synchronises opening, closure and reopening following an obstacle during closure, and the activation of the flashing lights.

For an obstacle during opening, the safety devices (safety edges) are each installed on the relative wing and they act independently.

Define which automation is the MASTER and which is the SLAVE.

The MASTER automation may be the one chosen to be only partially opened (1-20 connected).

1. Disconnect connectors 1-G1-G3 from the control panels.
2. Set the following parameters on both automations via the display:

Setting advanced parameters



Setting input mode

AP > G 1 > SY

Set automation parallel mode

AP > PA > 0 1

Set BC > SO > OF.



NOTE: if SO > ON, command 1-8 will trigger the stoppage of the wing movement if one wing is closed and the other is closing (without reopening the closed wing).

Do NOT alter the setting of parameter AP > SM > 00.

3. Reconnect connectors 1-G1-G3.
4. Enable automatic closure on the MASTER automation only, with BC > AC > ON. or with BC > AC > 1-2 (if you want to use a timer).
5. Set the required automatic closing time (BA > TC) on the MASTER automation (high enough to allow the SLAVE automation to open completely). With these settings, the automations will make simultaneous closing operations at the end of the time set by the MASTER automation TC.
6. Install a single GOLR - GOL868R radio receiver on the MASTER automation.

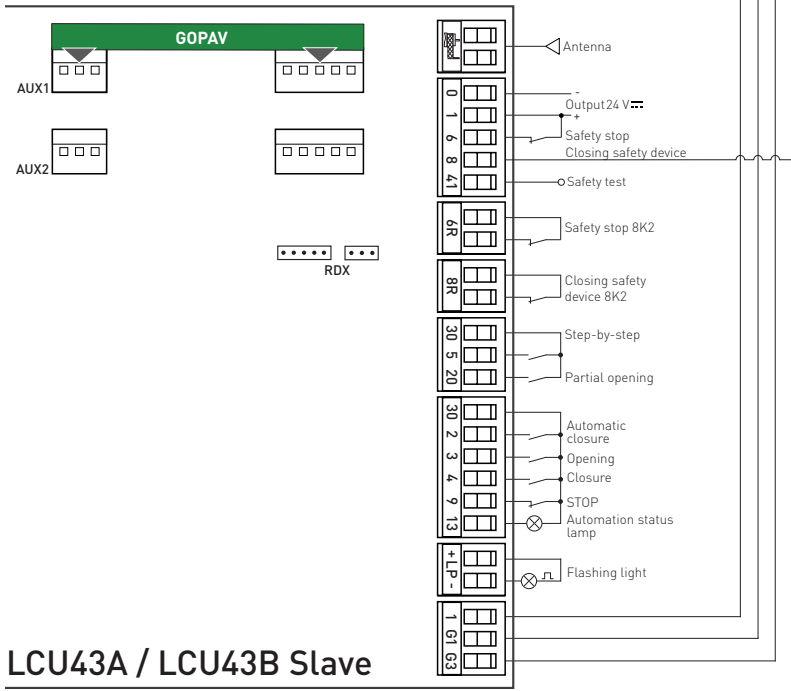
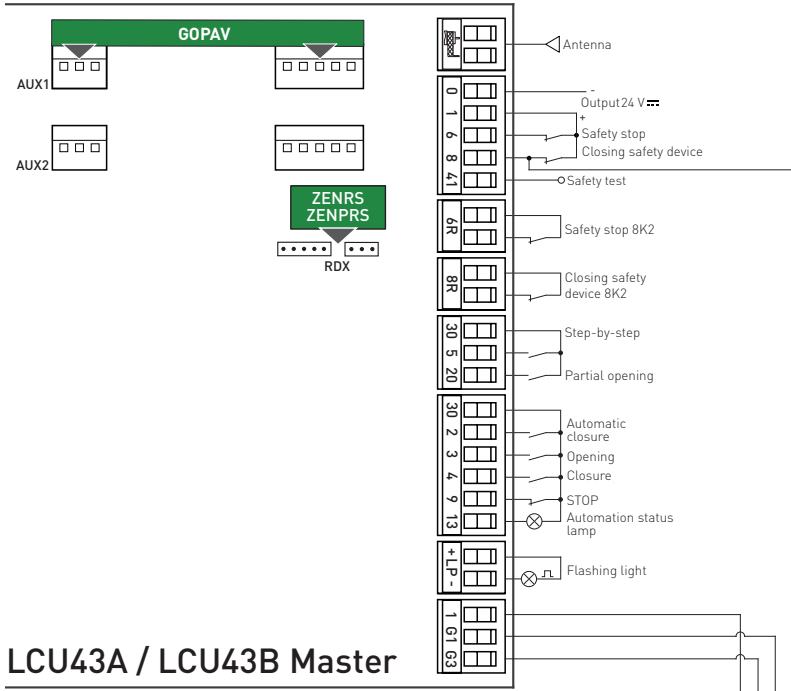

IP2336EN

13.1 Examples of application for interlocked automations with one-way or two-way transit, without presence detection

With these settings, command 1-3 launches an opening operation on the automation it is connected to, with closure after the time set with **BA > TC**.

Once the delay time set with **AP > TO** has elapsed, the other automation will open. It will close after the time set with **BA > TC**.

Commands 1-5, 1-4 and 1-20 can be used in special cases, for instance to allow very long vehicles to pass through.

Command 1-9 can be used to interrupt the interlocking sequence - i.e. annul the command given to automation B.

1. Disconnect connectors 1-G1-G3 from the control panels.

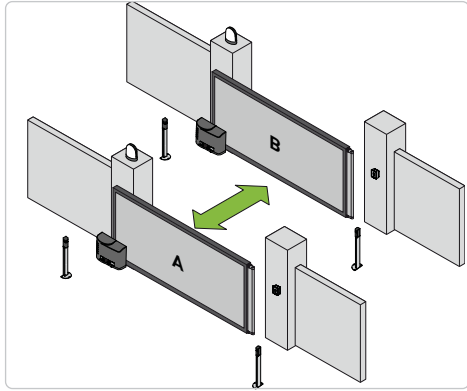

2. Set the following parameters on both automations via the display:

Setting advanced parameters

AT > AA  **OK**

Setting input mode

AP > G 1 > 5 Y

Set automation parallel mode

AP > PA > 02

3. Reconnect connectors 1-G1-G3.

4. Set **BC > RM > 1-3** on both automations.



NOTE: you are advised to store two different keys of the transmitter rather than just one [e.g.: key 1 to open automation A and key 2 to open automation B].

5. If required, enable automatic closure **BC > AC > ON** on both automations.

6. Set the required automatic closure time (**BA > TC**) on both automations.

7. Set the delay time **AP > TO** (from 0 to 30s) on both automations.

8. The booking function **BC > PG > ON** can be enabled on both automations if a vehicle arrives from the same direction while another one is still in transit. A second opening command is stored and executed as soon as the cycle in progress terminates.



NOTE: it is advisable to use booking with one-way transit only, or at least with limited traffic in the case of two-way transit.

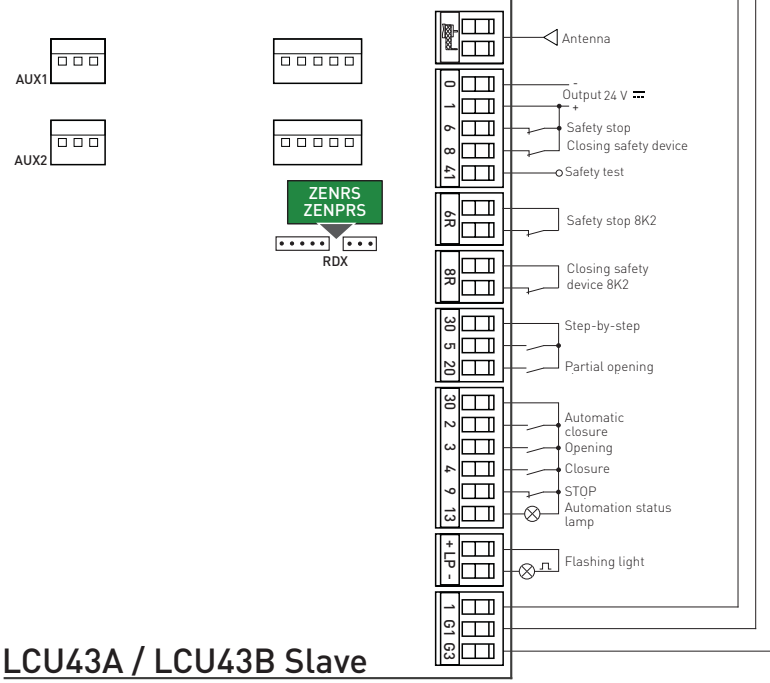
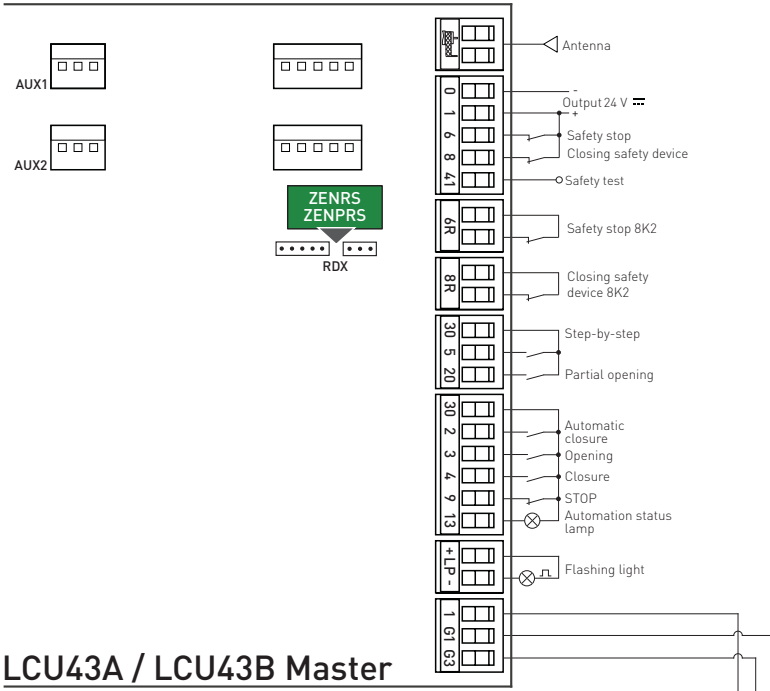

13.2 Examples of application for interlocked automations with one-way transit, with presence detection

With these settings, command 1-3 launches an opening operation on the MASTER automation, with closure after the time set with **BA > TC** but only once the vehicle has activated the detection device installed between the two automations (e.g. a magnetic loop).

Once the delay time set with **AP > TD** has elapsed, the SLAVE automation will open. It will close after the time set with **BA > TC**.

Commands 1-5, 1-4 and 1-20 can be used in special cases, for instance to allow very long vehicles to pass through.

Command 1-9 can be used to interrupt the interlocking sequence - i.e. annul the command given to the SLAVE automation.

1. Disconnect connectors 1-G1-G3 from the control panels.
2. Set the following parameters on both automations via the display:

Setting advanced parameters

AT > AA  
0.2 s

Setting input mode

AP > G 1 > S Y

Set automation parallel mode

AP > PA > 03

With this setting, the SLAVE automation does not close as long as contact 1-2 of the MASTER automation is active.

3. Reconnect connectors 1-G1-G3.
4. Set **BC > RM > I-3** on the MASTER automation.
5. Enable automatic closure on the MASTER automation with **BC > AC > I-2**, and on the SLAVE automation with **BC > AC > ON**.
6. Set the required automatic closure time (**BA > TC**) on both automations.
7. It is advisable (but not compulsory) to install a single GOLR - GOL868R radio receiver on the MASTER automation.
8. Set the delay time **AP > TD** (from 0 to 30s) on the MASTER automation.
9. The booking function **BC > PG > ON** can be enabled on the MASTER automation if a vehicle arrives from the same direction while another one is still in transit. A second opening command is stored and executed as soon as the cycle in progress terminates.

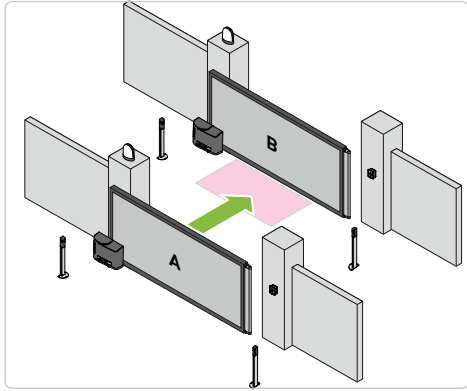

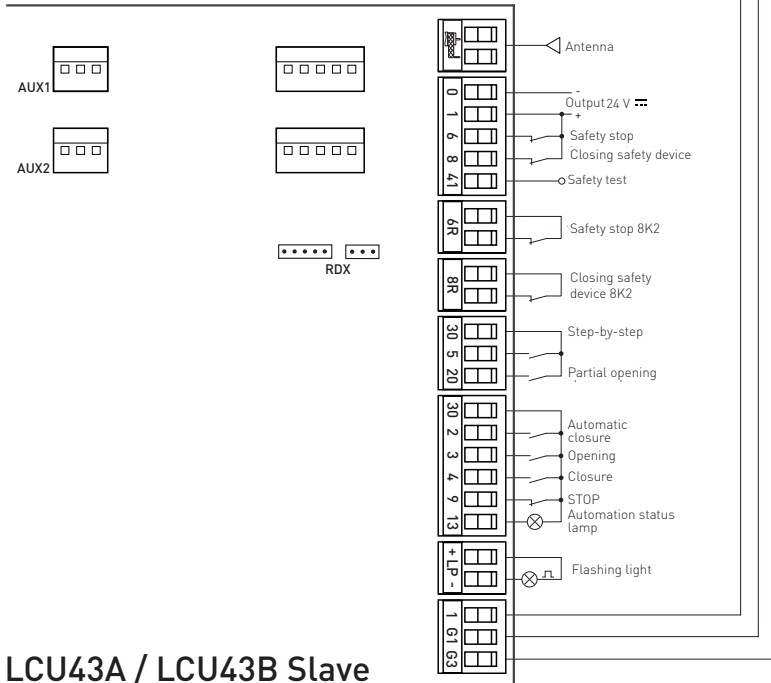
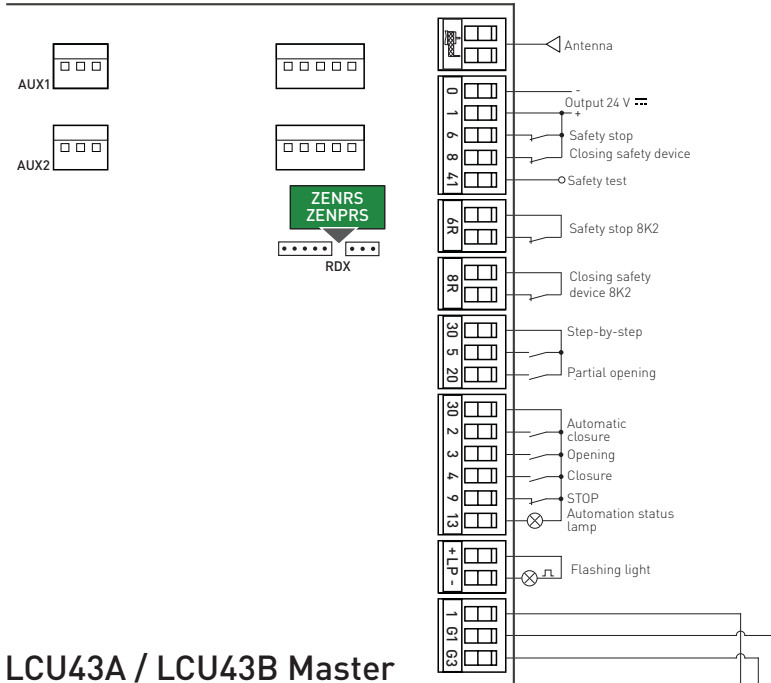

14. Signals visualised on the display

i **NOTE:** it is possible that, owing to the type of automation and control panel, certain visualisations are not available.

14.1 Display of automation status

i **NOTE:** the automation status display mode is only visible with Display visualisation mode set to 02.

AP ▶ DS ▶ 02

Display	Description
DM ▶ RT	
	Automation closed.
	Automation closed. Release door open.
	Automation open.
	Automation open. Release door open.
	Automation stopped in intermediate position.
	Automation stopped in intermediate position. Release door open.
	Automation closing.
	Automation that slows down during closing.
	Automation opening.
	Automation that slows down during opening.

Display	Description
DM ▶ LF	
	Automation closed.
	Automation closed. Release door open.
	Automation open.
	Automation open. Release door open.
	Automation stopped in intermediate position.
	Automation stopped in intermediate position. Release door open.
	Automation closing.
	Automation that slows down during closing.
	Automation opening.
	Automation that slows down during opening.

14.2 Display of safety devices and commands

i **NOTE:** the safety device and command display mode is only visible with Display visualisation mode set at 01 or 03.

AP ▶ DS ▶ 01

AP ▶ DS ▶ 03

Display	Description	Display	Description
1-2	1-2 - Automatic closure enable command.	1-6	1-6 - Safety device with stop during opening and closing.
1-3	1-3 - Opening command.	1-8	1-8 - Safety device with reversal during closing operation.
1-4	1-4 - Closure command.	1-9	1-9 - STOP command.
1-5	1-5 - Step-by-step control.	68	68 - Simultaneous opening of contacts 6-8 (only with AP > 68 = SE or S41)

P3	P3 - Partial opening command.	RV	RV - Enable/disable built-in radio receiver via RDX.
3P	3P - Opening command with hold-to-run.	MQ	MQ - Magnetic limit switch learning operation in progress.
4P	4P - Closing command with hold-to-run.	HT	HT - Motor heating (NIO function) in progress.
RX	RX - Radio reception (from any memorised key of a transmitter stored in memory).	J1	JR1 - Change in jumper JR1 status.
NX	NX - Radio reception (from any non-memorised key). NOTE: with the selection AP → JS → 0 1 , it is also visualised when a command is received from a non-stored transmitter.	ES	ES - Switch to Green Mode (energy-saving).
EX	EX - Rolling-code radio reception out of sequence.	SD	SD - Recognition of microSD card.
EP	EP - Radio reception not compliant with parameter configuration RO → EP	ED	ED - Log storage on the microSD.
CX	CX - Command received from AUX1 board.	6R	6R - Safety device with stop during opening and closure.
CY	CY - Command received from AUX2 board.	8R	8R - Safety device with reversal during closure.
FC	FC - Closure limit switch.	G1	G1 - General Purpose 1
FA	FA - Opening limit switch.	A0	A0 - Booking of opening command with interlocked automations
SW	SW - Release door open. When the release door is closed, the control panel runs a RESET (alarm XX). The reset can be ignored by pressing the ESC & DOWN keys for 3 seconds until SW stops flashing. ! If the RESET is disabled, make sure the gate is not moved manually NOTE: the reset is activated again if you return to the menu.		NOTE: if the door is open and synchronisation is active [G1= SY], the serial protocol is suspended and the other card will display notification I2. If the protocol remains suspended (or the cable is disconnected) for longer than 20s, the card showing I2 will be reset (XX). If the protocol becomes active again within 20s, notification I2 will disappear.

14.2.1 Messages visible if G1= SY

A	A - The MASTER card has sent an interlocked opening command.
C	C - The MASTER card has sent a simultaneous closure command
E	E - The SLAVE card is indicating that it has completed the interlocked closure (end of interlocked sequence)
L	L - The MASTER card is blocking the arrival of commands 1-3 (start of interlocked sequence)
O	O - The MASTER card has sent a simultaneous opening command
P	P - The MASTER card has sent a stop command 1-9 (deletion of interlocked sequence)
X	X - This card sees the other one in a RESET condition (XX)
I2	I2 - The other card cannot be detected (no messages arriving on G1)

















14.3 Visualisation of alarms and faults



WARNING: the visualisation of alarms and faults is possible with any visualisation selection. The signalling of alarm messages takes priority over all other displays.

Type of alarm	Display	Description	Operation	Type of alarm
Mechanical alarm	M3	M3 - Automation blocked or opening / closing limit switch not disengaged within 3 s	Check the mechanical parts	Non-blocking if it occurs less than 3 times in a row (see M9)
	M4	M4 - Motor short circuit.	Check connection of motor.	
	M6	M6 - Brake absent or circuit open. Non-fatal alarm. ⚠️ WARNING: CROSS20VEI only	Check the brake connection.	
	M7	M7 - Short circuit or brake overload. Fatal alarm. ⚠️ WARNING: CROSS20VEI only	Check the brake connection.	Blocking - ✖2
	M9	M9 - More than 2 consecutive M3 alarms	Check the mechanical parts	✖2
	MI	MI - Current threshold exceeded 3 consecutive times.	Check for the presence of permanent obstacles along the stroke of the automation.	Blocking
	MF	MF - Incorrect limit switch operation	Check the limit switch connections.	
	ML	ML - Limit switches inverted	Check the connection or swap the limit switches over.	
	MJ	MJ - Irregular operation of motor opening limit switch.	Check connection of the motor opening limit switch.	Blocking
	ME	ME - Irregular operation of motor closure limit switch.	Check connection of the motor closing limit switch.	Blocking
	OD	OD - motor overcurrent during OPENING	Check the mechanical parts and that they move freely	
	OE	OE - motor overcurrent during CLOSURE	Check the mechanical parts and that they move freely	
	OF	OF - motor overcurrent with boost active during OPENING	Check the mechanical parts and that they move freely	
	OG	OG - motor overcurrent with boost active during CLOSURE	Check the mechanical parts and that they move freely	
Alarm Settings	S6	S6 - Incorrect setting of safety device test.	Check the configuration of parameters 06, 08, 68 . If 68 → 54 , 06 and 08 cannot be 41 or 54 .	
Service alarm	V0	V0 - Maintenance request.	Proceed with the scheduled maintenance intervention.	
	VH	VH - motor thermal protection switch alarm	Check the connection and condition of the motor thermal protection switch. In the event of an alarm due to high engine speed, wait for the engine to cool down.	Blocking - ✖2
Internal control panel alarm	I5	I5 - No voltage 0-1 (voltage regulator faulty or short circuit on accessories).	Check there is no short circuit in connection 0-1 and that the sum of the currents delivered to the accessories does not exceed the limit indicated in the electrical data. If the problem persists, replace the control panel.	Blocking

Type of alarm	Display	Description	Operation	Type of alarm
Internal control panel alarm	I6	I6 - Excessive voltage 0-1 (faulty voltage regulator).	Replace the control panel.	Blocking
	I7	I7 - Internal parameter error - value outside limits.	Reset. If the problem persists, replace the control panel.	Blocking - *2
	I8	I8 - Program sequence error.	Reset. If the problem persists, replace the control panel.	Blocking - *2
	IA	IA - Internal parameter error (EEPROM/FLASH).	Reset. If the problem persists, replace the control panel.	Blocking - *2
	IB	IB - Internal parameter error (RAM).	Reset. If the problem persists, replace the control panel.	Blocking - *2
	IC	IC - Operation time-out error (>5 min or >7 min in learning mode).	Check the correct coupling between pinion and rack. If the problem persists, replace the control panel.	
	IE	IE - Internal error.	Reset. If the problem persists, replace the control panel.	Blocking - *2
Internal control panel alarm	IM	IM - Short circuit on motor control circuit.	Reset. Check the settings / operating of any limit switches. If the problem persists, replace the control panel.	Blocking after two consecutive repeats after start-up
	IO	IO - Motor control circuit open.	Reset. If the problem persists, replace the control panel.	Blocking - *2
	IS	IS - Error on current read circuit test - motor 1.	Reset. If the problem persists, replace the control panel.	Blocking after two consecutive repeats after start-up
	IU	IU - Motor 1 voltage reading circuit test error.	Reset. If the problem persists, replace the control panel.	Blocking - *2
	ID	ID - Motor control system error.	Reset. If the problem persists, replace the control panel.	Blocking - *2
	IK	IK - Motor control system error.	Reset. If the problem persists, replace the control panel.	Blocking - *2
	IJ	IJ - Motor control system error.	Reset. If the problem persists, replace the control panel.	Blocking - *2
	IL	IL - Motor control system error.	Reset. If the problem persists, replace the control panel.	Blocking - *2
	IR	IR - Motor control system error.	Reset. If the problem persists, replace the control panel.	Blocking after two consecutive repeats after start-up
	XX	XX - Firmware reset commanded by simultaneous pressing of  +  keys.		
	WD	WD - Firmware reset not commanded.		

Type of alarm	Display	Description	Operation	Type of alarm
Radio operations alarm		R0 - Storage module installed containing over 100 stored remote controls.  WARNING: the R0→MU→20 setting is made automatically.	To save the system configurations on the storage module, delete any stored remote controls and bring the total to less than 100. Set R0→MU→10 .	
		R3 - Storage module not detected.	Insert a storage module.	
		R4 - Storage module not compatible with the control panel.	Insert a compatible storage module.	
		R5 - No serial communication with the storage module.	Replace the storage module.	
		R6 - Specific storage module for testing installed.		
	Power supply alarm		P1 - Insufficient microswitch voltage.	Check the control panel is powered correctly.
		IT - Short drop in power supply or power failure.	If the alarm occurs several times, check the electrical connections and power supply.	
Accessories alarm		A0 - Test of safety sensor on contact 6 failed.	Check the device SOFA1-A2 is working correctly. If the supplementary SOF card is not inserted, check the safety test is disabled.	
		A1 - Test of safety sensor connected simultaneously to contacts 6 and 8 failed.	Check the wiring and correct operation of the safety sensor.	
		A3 - Test of safety sensor on contact 8 failed.	Check the device SOFA1-A2 is working correctly. If the supplementary SOF card is not inserted, check the safety test is disabled.	
		A5 - Test of safety sensor on contact 6 failed.	Check the edge is working properly.	
		A6 - Test of safety sensor on contact 8 failed.	Check the edge is working properly.	
		A7 - Incorrect connection of contact 9 to terminal 41.	Check that terminal 1 and 9 are correctly connected.	
		A9 - Overload on output +LP-.	Check the device connected to output +LP- is working properly.	
		AB - Overload on output 30-13.	Check the device connected to output 30-13 is working properly.	

NOTE: the blocking alarms prevent operating of the automation system.

*1: self-resetting alarm

*2: perform a reset - switch the electronic control panel off and on again or perform a firmware reset (simultaneous pressing of the



15. Troubleshooting

Problem	Possible cause	Alarm signal- ling	Operation	
The electronic panel does not switch on.	No power supply.		Check the power supply cable and the relative wiring.	
	Overload on output 0-30.		Disconnect any loads connected to terminal 30.	
The automation does not open or close.	No power.	IS	Check power supply cable.	
	Short circuited accessories.		Disconnect all accessories from terminals 0-30 (a voltage of 24 V= must be present), then reconnect them one at a time. Contact Technical Service	
	Safety contacts are open.		I-6 68 I-8	Check that the safety contacts are closed correctly (NC).
	Safety contacts not correctly connected or self-controlled safety edge not functioning correctly.		A0 I-6 A1 I-8 A3 68	Check connections to terminals 6-8 on control panel and connections to the self-controlled safety edge.
	Photocells activated.		I-6 I-8	Check that the photocells are clean and operating correctly.
	The automatic closure does not work.			Issue any command. If the problem persists, contact Technical Service
The automation opens/closes briefly and then stops.	There is a presence of friction.	MI OD MI OE OF	Manually check that the automation moves freely and check the R1/R2 adjustment. Check that the limit switches, if installed, are working correctly Contact Technical Service	
The external safety devices are not activated.	Incorrect connections between the photocells and the control panel.		Check that I-6 / I-8 is displayed Connect NC safety contacts together in series and remove any jumpers on the control panel terminal board. Check the AP → J6 and AP → J8 setting	
The remote control has limited range and does not work with the automation moving.	The radio transmission is impeded by metal structures and reinforced concrete walls.		Install the aerial outside.	
			Replace the transmitter batteries.	
The remote control does not work	No storage module or incorrect storage module.	R0 R3 R5	Switch the automation off and plug in the correct storage module. Check the correct memorisation of the transmitters on the built-in radio. If there is a fault with the radio receiver that is built into the control panel, the remote control codes can be read by removing the storage module.	

16. Maintenance

IP2336EN

The control panel doesn't require any special maintenance.

Make regular checks to ensure the seals on the box and the electrical connections are in good condition.

All the rights concerning this material are the exclusive property of ASSA ABLOY Entrance Systems AB. Although the contents of this publication have been drawn up with the greatest care, ASSA ABLOY Entrance Systems AB cannot be held responsible in any way for any damage caused by mistakes or omissions in this publication. We reserve the right to make changes without prior notice.

Copying, scanning or changing in any way is expressly forbidden unless authorised in writing by ASSA ABLOY Entrance Systems AB.

 The crossed-out wheeled bin symbol indicates that the product should be disposed of separately from normal household waste. The product should be recycled in accordance with local environmental regulations for waste disposal. By separating a product marked with this symbol from household waste, you will help reduce the volume of waste sent to incinerators or land-fill and minimise any potential negative impact on human health and the environment.



ASSA ABLOY Entrance Systems AB
Lodjursgatan 10
SE-261 44, Landskrona
Sweden
© ASSA ABLOY